

KOHLER®

UNINTERRUPTIBLE
POWER



KOHLER ELMOD SERIES

4-24kVA

User Manual

Document Control

ISSUE	DATE	REVISION SUMMARY
TS_883_01	30/07/2024	Rebranding to KUP
TS_883_02	23/04/2025	Removed 3 phase input

Useful Contacts

UK

www.kohler-ups.co.uk	Kohler Uninterruptible Power web site
ukservice.ups@kohler.com	Service department – booking service, fault reporting etc.
uktechnicalsupport.ups@kohler.com	Technical queries
uksales.ups@kohler.com	Hardware sales
ukservicesales.ups@kohler.com	Extended warranty agreements etc

CONTENTS

CHAPTER 1 – SAFETY WARNINGS	4
1.1 DESCRIPTION OF SYMBOLS USED IN THIS MANUAL	4
1.2 GENERAL WARNINGS	4
1.3 BATTERY SAFETY	5
CHAPTER 2 – GENERAL DESCRIPTION	6
2.1 INTRODUCTION	6
2.2 FUNCTIONAL DESCRIPTION	7
2.3 MODES OF OPERATION	8
2.3 COMPONENT DESCRIPTION	10
2.3.1 CABINET	10
2.3.2 4kVA POWER MODULES	12
2.3.3 CONTROL MODULE	13
2.3.4 DISPLAY SUB MENU	15
CHAPTER 3 – INSTALLATION	16
3.1 INTRODUCTION	16
3.2 ACCEPTING DELIVERY	17
3.2.1 REPORTING DAMAGE	17
3.2.2 STORAGE	17
3.2.3 UNPACKING INSTRUCTIONS	17
3.3 INSTALLATION	18
3.3.1 ENVIRONMENTAL CONSIDERATIONS	18
3.3.2 CLEARANCES	19
3.3.4 CABLE CONSIDERATIONS	19
3.3.5 INRUSH CURRENT	20
3.3.6 CABLE SPECIFICATION	21
3.3.7 ELECTRICAL PLANNING	21
3.3.8 CABLINING PROCEDURE	21
3.3.8.1 SAFETY NOTES	21
3.3.8.2 TERMINAL CONNECTIONS	22
CHAPTER 4 – OPERATION INSTRUCTIONS	24
4.1 START UP	24

4.2 SHUT DOWN.....	24
4.3 POWER MODULE REMOVAL	25
4.4 POWER MODULE INSTALL.....	25
4.5 KEYSWITCH.....	26
CHAPTER 5 – MAINTENANCE INSTRUCTIONS	27
5.1 EMERGENCY LIGHTING MAINTENANCE.....	27
5.2 SCHEDULED MAINTENANCE	27
CHAPTER 6 – TROUBLE SHOOTING	28
6.1 ALARM TABLE.....	29
CHAPTER 7 – COMMUNICATION	30
7.1 INTRODUCTION	30
7.2 TERMINAL BLOCK CONNECTIONS	30
7.2.2 EMERGENCY POWER OFF	30
7.2.3 IN1 & IN2.....	30
7.2.4 DRY PORT CONTACTS.....	31
7.3 BATTERY TEMPERATURE SENSING.....	32
7.4 SNMP CARD SLOT.....	32
CHAPTER 8 – TECHNICAL SPECIFICATION	33
8.1 EL POWER MODULE TECHNICAL SPECIFICATION.....	33
8.2 ELMOD SYSTEM TECHNICAL SPECIFICATION	33

CHAPTER 1 – SAFETY WARNINGS

Read the following safety information carefully before you install or operate the KOHLER ELMOD Static Inverter (SI) equipment and keep this manual within easy access of the equipment for future reference.

1.1 DESCRIPTION OF SYMBOLS USED IN THIS MANUAL



WARNING: The warning symbol is used where there is danger of an electrical shock, equipment damage or personal injury.



CAUTION: The caution symbol is used to highlight important information to avoid possible equipment malfunction or damage.

1.2 GENERAL WARNINGS



WARNING: Be aware that the output from this equipment can be energized when the unit is not connected to a mains supply, even when the input AC power is disconnected



WARNING: The ELMOD assembly and peripheral equipment must be installed and commissioned by suitably qualified and trained personnel who are aware of the potential shock hazards.



WARNING: The ELMOD must be supplied by a grounded outlet. Do not operate the unit without a ground source.



WARNING: To reduce the risk of electric shock:

- Do not insert any object into ventilation holes or other openings
- Do not remove any equipment cover – the unit does not contain any user-serviceable parts. Refer all servicing requirements to qualified service personnel.
- Always disconnect the ELMOD from the mains power supply before you install a computer interface signal cable. Reconnect the power only after the signalling interface connections have been made



WARNING: To reduce the risk of fire:

- Install this equipment in a temperature and humidity controlled indoor area free of conductive contaminants.
- If a fuse ruptures always replace it with a fuse of the same type and rating.

1.3 BATTERY SAFETY



WARNING: The battery is not isolated from the mains voltage. Hazardous voltage may occur between the battery terminals and ground.



WARNING: A battery can present a risk of electric shock or burn from high short circuit currents. Always take the following precautions when working on batteries:

- Remove watches, rings or other metal objects.
- Use tools with insulated handles.



WARNING: The ELMOD system uses recyclable batteries:

- The batteries contain lead and pose a hazard to the environment and human health if not disposed of properly.
- If you replace the batteries you must dispose of the used batteries in accordance with local environmental laws and regulations.



WARNING: Heed the following warnings concerning battery handling:

- Do not dispose of batteries in a fire. The batteries may explode.
- Do not open or mutilate the batteries. They contain an electrolyte which is toxic and harmful to the skin and eyes.
- If electrolyte comes into contact with the skin, the affected area should be washed immediately with clean flowing water.
- The internal energy source (the battery) cannot be de-energized by the user.



WARNING: When changing the batteries, install the same number and same type of batteries.

CHAPTER 2 – GENERAL DESCRIPTION

2.1 INTRODUCTION

The ELMOD is a high performance Emergency Lighting Static Inverter (SI) system, designed to deliver complete emergency lighting protection for a range of applications, in accordance with European BS EN50171 specification.

Key features

High performance, single input and single phase output, modular static inverter system ranging from 4kVA to 24kVA.

- Power cabinet, comprising up to six 4kVA power modules
- Selectable single-phase or three-phase input supply configuration
- Hot-swappable power modules reduce mean-time-to-repair (MTTR)
- Manufactured with the latest IGBT devices and PWM technology
- Fully DSP (Digital Signal Processor) controlled, pure sine wave output
- Output configurable to 3 modes of operation (Changeover/ Inverter/ Non-Maintained)
- No-break load transfer for use with discharge lamps
- Deep discharge battery protection
- Battery reverse polarity protection
- Battery short circuit protection
- Front access for all maintenance and repair
- 10min, 1 hour & 3 hour battery test key-switch
- Battery discharge management, auto-transfer between floating and equalisation charging with optional temperature compensation
- Inverter modules automatically share the input and output current, and battery charge/discharge current
- Multiple communication options RS232, RS485, dry-contacts, TCP/IP adapter for local and remote communication
- Compliant to BS EN50171.

Optional features

- Input/output transformer
- Load distribution
- Internal maintenance bypass switch
- DC Earth leakage protection
- High IP rating
- Other voltage options

Model Range

	ELMOD 04	ELMOD 08	ELMOD 12	ELMOD 16	ELMOD 20	ELMOD 24
Power Rating Kva/Kw	4 / 3.6	8 / 7.2	12 / 10.8	16 / 14.4	20 / 18	24 / 21.6
Input AC Voltage	220/230/240 (1Ph + N + PE)					
Output AC Voltage	220/230/240 (1Ph + N + PE)					
Battery	internal	External				

2.2 FUNCTIONAL DESCRIPTION

The ELMOD is a modular Static Inverter (SI) comprising a control module and up to six, hot-swappable, 4kVA power modules. It produces a single-phase output and can be configured to operate with either a single-phase or three-phase input supply.

Depending on the number of fitted power modules, the ELMOD system can provide an output rated between 4kVA and 24kVA in 4kVA increments.

Each 4kVA module contains a rectifier, charger and inverter.

The Control module contains the static switch power section and monitoring sections

The modules are all accessed from the front of the cabinet with all power connections located on the back of the ELMOD cabinet.

Note: The input and output power connections are not switched within the standard cabinet so suitable external power switches and protective devices must be provided as part of the cabinet installation – as described in Chapter 3.

RECTIFIER: In ELMOD Series EL INVERTERS, a controlled IGBT rectifier with PWM technique is used to increase input power factor (PFC) and to decrease input current harmonics (THDI). The IGBT rectifier accepts AC input and produces a dual polarity DC voltage for both supplying the inverter and charging the batteries.

BATTERIES: Batteries are used as reserve DC power supply for the Inverter in case of mains failure. Batteries are connected in series with a centre-tap output to obtain a dual polarity DC supply. Batteries are discharged by the inverter during mains failure. The discharged batteries are re-charged by the IGBT Rectifier on a constant voltage / current limiting basis, if AC mains power is available.

INVERTER: It is manufactured by using the latest IGBT and DSP (Digital Signal Processing) technologies, and Pulse Width Modulation (PWM) technique. The Inverter converts the DC BUS voltage supplied by the IGBT Rectifier and / or the batteries into a well-regulated, fully digital controlled AC voltage with fixed voltage and frequency.

The output of the inverter is used to supply the critical loads connected to the EL INVERTER output.

STATIC TRANSFER SWITCH (STS): This is an electronically controlled transfer switch, which enables the critical load to be connected either to inverter output or to by-pass power source. During normal operation, the load is supplied by the inverter output, but in case of an overload or a EL INVERTER failure it is automatically transferred to the bypass source without any interruption.

2.3 MODES OF OPERATION

The ELMOD can be configured to operate in one of three modes to suit the degree of supply integrity required for a particular lighting application

Changeover mode

When operating in the 'changeover' mode the rectifier is turned on to provide battery charging. The inverter is turned on and operating on standby (off load) the bypass-side of the static switch is turned on to connect the SI OUPUT to the AC INPUT via the internal bypass line.

If the utility supply fails, the static switch will transfer the SI OUPUT to the inverter within 10ms. However, as the utility supply is in a failed state the rectifier is inoperative and the inverter will be powered solely from the batteries (see Figure 2.4).

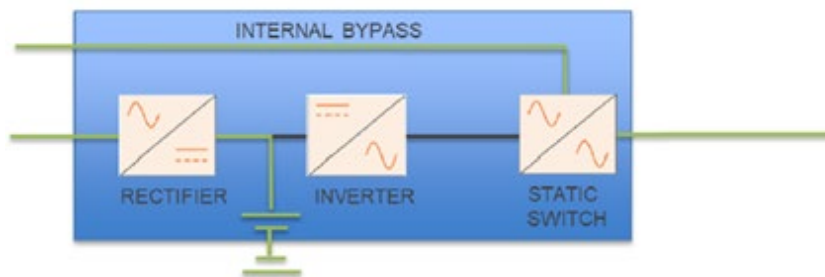

Figure 2.1

Inverter mode

When operating in the 'inverter' mode the rectifier is turned on to power the inverter and provide battery charging.

The inverter is turned on and the inverter-side of the static switch is turned on to connect inverter to the SI OUPUT.

The emergency luminaires are powered from the regulated inverter output.

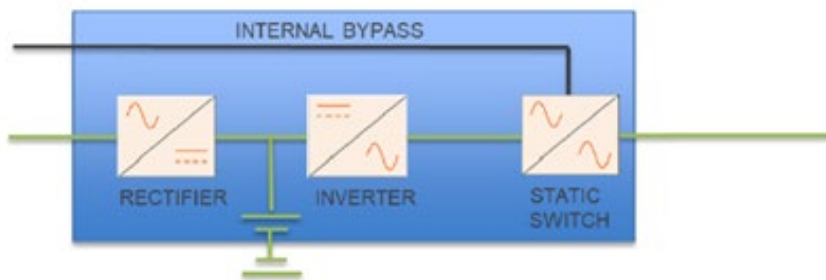

Figure 2.2

Non-Maintained mode

In this operating mode the unit can be viewed as operating purely as a ‘standby’ power supply as the ELMOD is not called upon to provide any SI OUTPUT power under normal circumstances.

When the mains supply is available the rectifier is turned on to power the inverter and provide battery charging, the inverter is turned on and both the inverter and bypass sides of the static switch are turned off, so the SI OUTPUT is not live.

If the mains supply fails, the static switch immediately closes its inverter-side switch which connects the inverter to the SI OUTPUT; however, as the utility supply is in a failed state the rectifier is inoperative and the unit immediately enters its ‘on battery’ operation (see Figure 2.4).

If the utility mains is restored before the batteries are fully discharged, the system will revert to its normal operating state; the rectifier will turn on to recharge the batteries but the static switch will once again turn off both ‘sides’ and effectively once more disconnect the UPS OUTPUT. That is, the ELMOD will revert to its stand-by function.

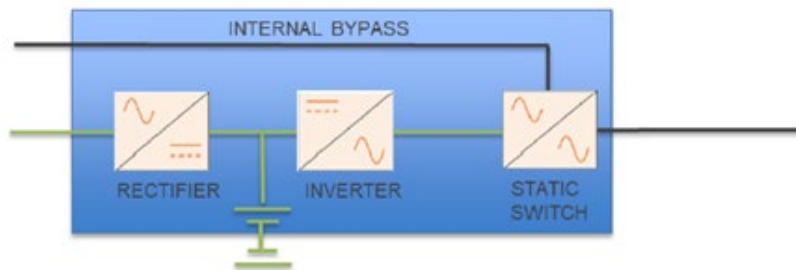

Figure 2.3

On battery operation

If the mains supply fails, the rectifier will turn off, but the inverter will continue to operate from battery power until the batteries reach their end-of-discharge voltage; at which point the inverter will shut down and disconnect the SI OUTPUT supply.

If the AC INPUT supply is restored before the batteries are fully discharged, the rectifier will turn on automatically to once again power the inverter and recharge the batteries.

The whole process of switching between rectifier and battery power is totally transparent to the emergency luminaires.

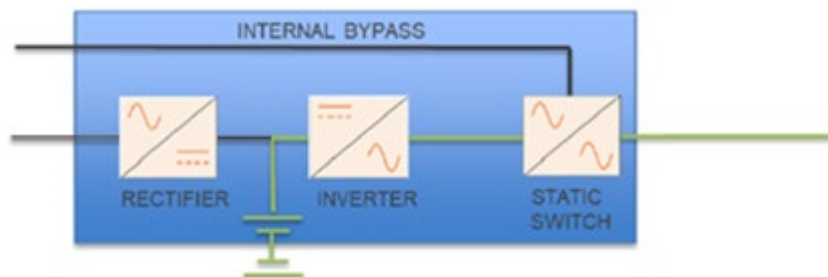

Figure 2.4

2.3 COMPONENT DESCRIPTION

2.3.1 CABINET

The ELMOD cabinet, shown in Figure 2.5, comprises up to six, 4kVA modules and a single control panel assembled in a purpose-designed chassis. The modules and the control module can be fitted/removed from the front of the cabinet, making side and rear access unnecessary for servicing or repair.

All the AC and DC power cables are connected to terminals located on the rear of the cabinet and gland plates are provided to enable top or bottom cable entry.

There are no power switches fitted to the 'standard' ELMOD cabinet so suitable switching and protective devices must be fitted externally for ALL the input and output power cables.

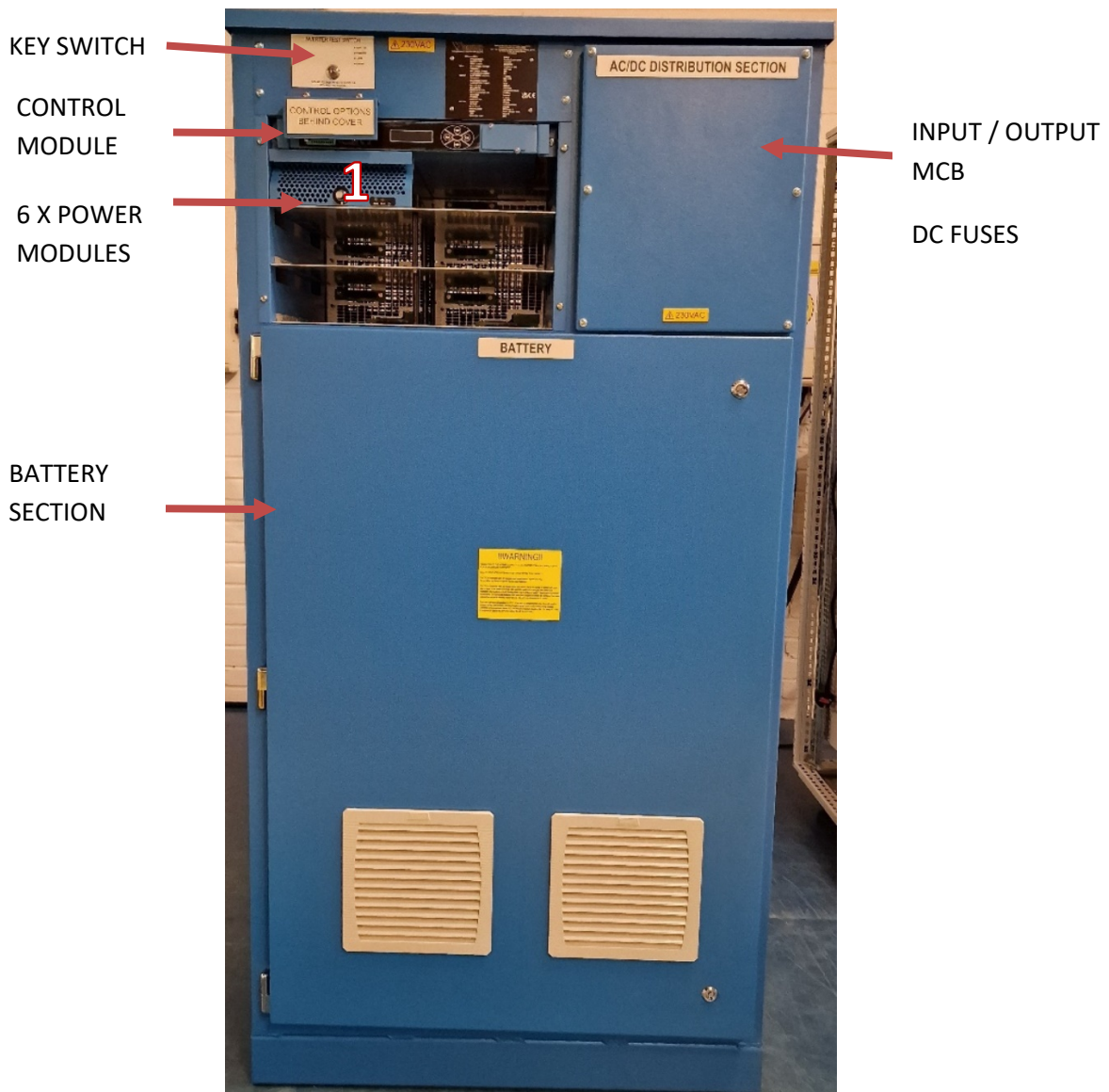

Figure 2.5A – 4kVA

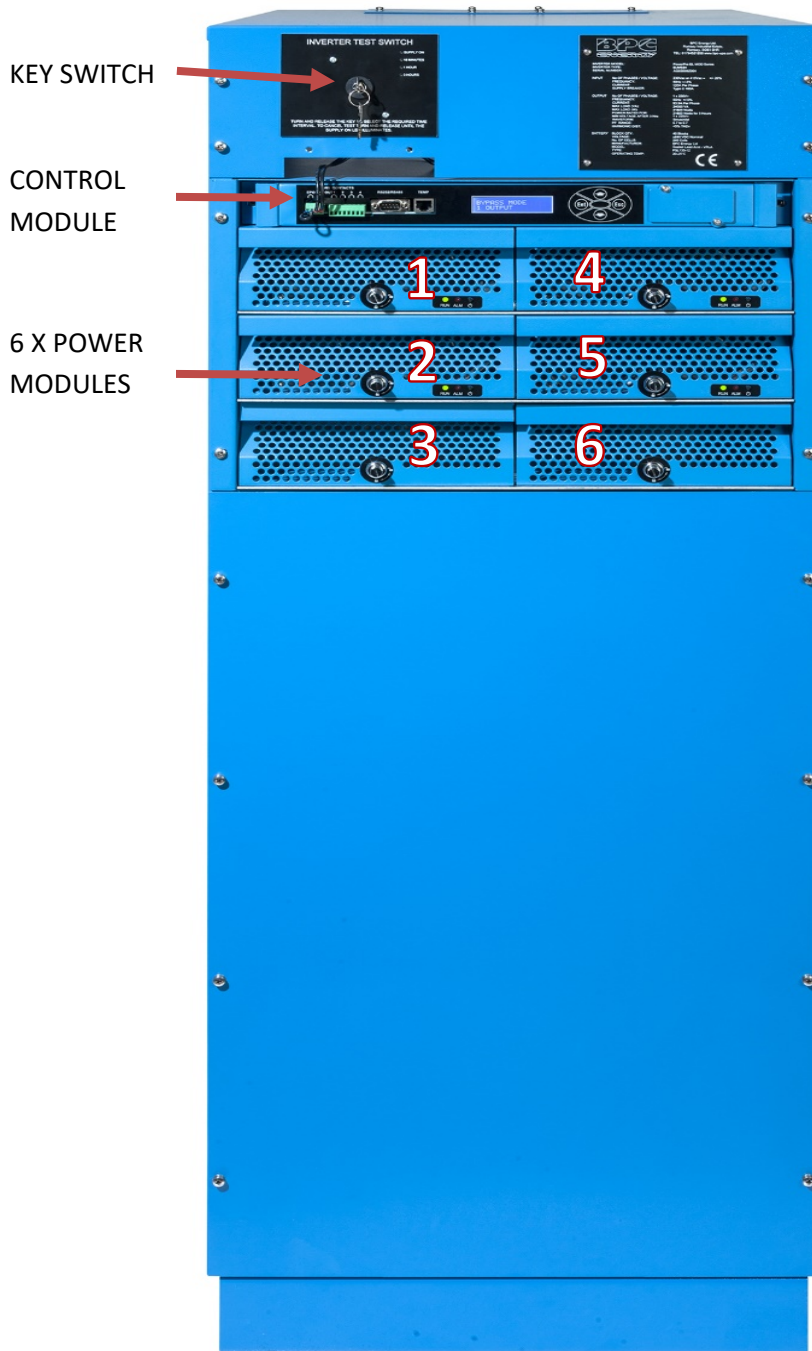

Figure 2.5B – 8 – 24Kva

2.3.2 4kVA POWER MODULES

The power modules are shelf-mounted and secured in place by a knurled, thumb-screw catch. Each module is assigned an ID number by the control system in order to identify a particular module for alarm and monitoring purposes. Figure 2.5 shows the designated module numbers.

The ELMOD system is expandable so, if the cabinet is not fully populated initially, additional power modules can be added to match any load expansion. When dealing with a single-phase fed system, the modules should be added in the order shown.

The power module contains two led indicators, as shown in Figure 2.6.

As its name suggests, the red alarm (ALM) led illuminates when the module detects an abnormal utility mains input, inverter output, overload, DC, fan failure, etc. The control panel display screen will indicate the exact nature of a fault.

The ALM led is off during normal module operation.

The green RUN led flashes for up to 2 minutes when the module goes through its start-up initialisation, and illuminates fully when the module is operating with the inverter turned on. When the module is not working, the RUN light will be off.

The ON/OFF button is used to turn the module On/Off when inserting/removing it from a working system.

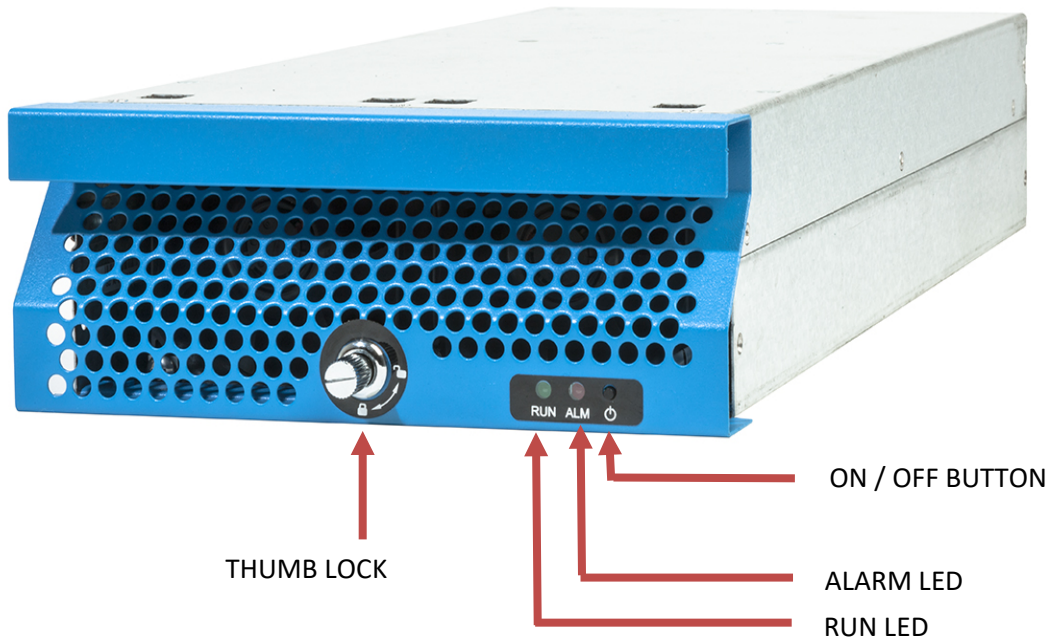

Figure 2.6

2.3.3 CONTROL MODULE

The 4kVA power modules are controlled from a central control panel installed on the top shelf of the cabinet. The control panel can be powered from either the mains supply or DC (battery) supply.

The control panel can be split into four areas, as shown in Figure 2.7.

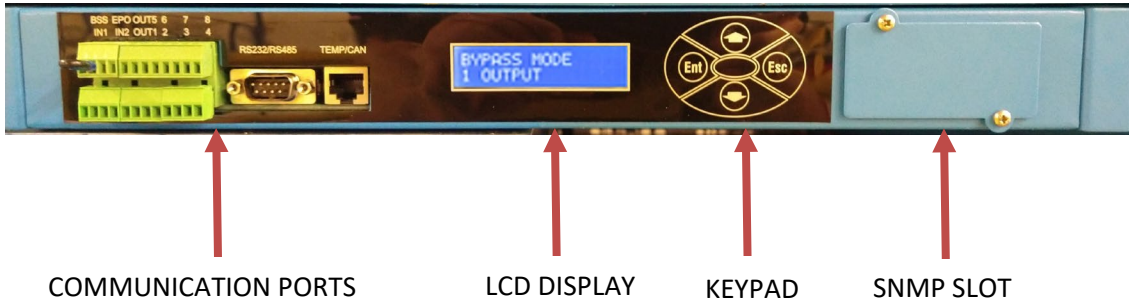

Figure 2.7

SNMP Slot

A range of SNMP/Ethernet communication interface cards can be plugged in to the TCP/IP adapter to provide communication with a remote computer or network. This is described in more detail in the Options chapter of the manual.

Communication ports

Several optional communication ports are provided on the left-hand side of the control panel. These are described in detail in the Options chapter of the manual, but include:

Dry contact terminal blocks:

- External emergency stop input
- System test input
- Operating status/alarm outputs; mains failure, common alarm, system on battery, low battery voltage.

RS232/RS485 interface:

- Standard 9-pin D-type connector provides RS232/RS485 computer communication over a range of approximately 50m at 9600 baud.

RJ45 Port:

- RS485 port used for battery temperature monitor.

NOTE: Only one communication port (SNMP, RS232 or RS485) can be used at any time. The active port is selected in the control panel SETUP screen as shown in the menu map in

Control keypad

The ELMOD is controlled via a 4-button keypad working in conjunction with a multilevel menu system that is displayed on the LCD.

On the keypad, the UP and DOWN arrow buttons are used to scroll through the presented menu options.

The Enter button (Ent) is used to 'select' the current menu item, and the Escape button (Esc) returns the LCD Display to the top-level menu from anywhere within the menu tree.

The Esc button is also used to cancel the audible alarm when activated.

LCD Screen

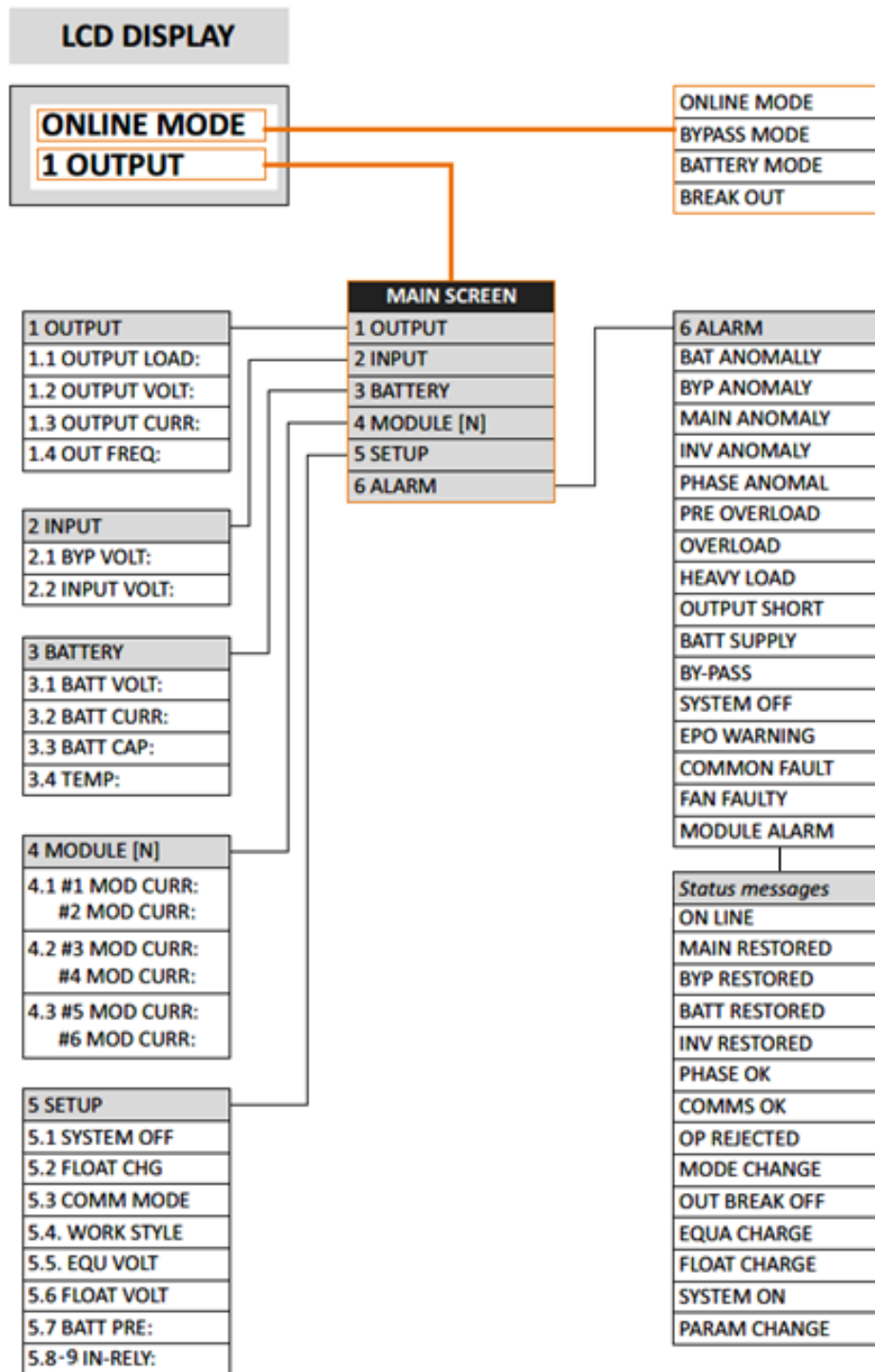

2.3.4 DISPLAY SUB MENU

1. OUTPUT		
1.1 OUT LOAD	Output Load Percentage – For Single Phase output only the first value will be shown.	80% 000% 000%
1.2 OUT VOLT	Output Voltage– For Single Phase output only the first value will be shown.	230V 000V 000V
1.3 OUT CURR	Output Current	20A 000A 000A
1.4 OUT FREQ	Output Frequency – One value shown for all phases.	50Hz

2. INPUT			
2.1 BYP VOLT	Bypass Voltage – All three values display same in single phase operation.	230V	230V 230V
2.2 INP VOLT	Rectifier Voltage – All three values display same in single phase operation.	230V	230V 230V

3. BATTERY			
3.1 BATT VOLT	Battery Voltage – Positive and Negative half voltages displayed.	+270V	-270V
3.2 BATT CURR	Battery Current – Charge and Discharge Current displayed (- Indicates Discharge).	+10A	-10A
3.3 OUT CAP	Battery Capacity shown as % of Voltage.	100%	
3.4 TEMP	Battery Temperature – Requires installation of optional Temperature Probe.	20C	

4. MODULE			
4.1	Module Number 1 & 2 Output Voltage and Output Currents.	#1	230V 10A
		#2	230V 10A
4.2	Module Number 3 & 4 Output Voltage and Output Currents.	#3	230V 10A
		#4	230V 10A
4.3	Module Number 5 & 6 Output Voltage and Output Currents.	#5	230V 10A
		#6	230V 10A

5. SETUP			
5.1 SYSTEM OFF	Switching the system On or Off.	YES	NO
5.2 FLOAT CHG / EQU CHG	Activating Equalisation (boost charge), In normal operation the charger is in Float mode. Use UP and DOWN arrows to select.	YES	NO
5.3 COMM MODE	Select communication mode using UP and DOWN arrows. RS232 selected as standard.	RS232 / RS485 / SNMP	
5.4 WORK STYLE	Select operation mode using UP and DOWN arrows. Changeover Mode selected as standard.	ON-LINE / CHANGEOVER / NON-MAINTAINED	
5.5 EQU VOLT	Equalisation (Boost) Voltage Adjustment, 284V as standard.	240V – 290V	
5.6 FLOAT VOLT	Float Voltage Adjustment, 272V as standard	240V – 290V	
5.7 BATT PRE	Battery Low Voltage Alarm Adjustment, 230V as standard	210 – 240V	
5.8 INRELY 1	Changes state of the Input Relay 1 – Select required function.	None / Manual Bypass / System off / Equalisation Charge/ Battery Test	
5.9 INRELY 2	Changes state of the Input Relay 2 – Select required function	None / Manual Bypass / System off / Equalisation Charge/ Battery Test	

6. CURRENT ALARMS SCREEN		
ALARMS	ALL Current Active Alarms Displayed	

CHAPTER 3 – INSTALLATION

3.1 INTRODUCTION



WARNING: All the operations described in this chapter must be supervised by suitably qualified personnel and all aspects of the electrical installation must be carried out by an authorised electrician.

Kohler Uninterruptible Power Ltd. will take no responsibility for any personal injury or material damage caused by incorrect cabling or operation, or any installation activities that are not carried out in strict accordance with the instructions contained in this manual



WARNING: Once the ELMOD system is installed it must be commissioned by an engineer approved by Kohler Uninterruptible Power Ltd, or one of its service agents, before it is powered-up.

Kohler Uninterruptible Power Ltd. will take no responsibility for any personal injury or material damage caused by the application of electrical power to this equipment before it has been fully commissioned.

3.2 ACCEPTING DELIVERY

The ELMOD cabinet is shipped on a purpose-built pallet that is easy to move with a forklift or a pallet truck. The power modules, batteries and other accessories are shipped separately.



CAUTION: Observe the following precautions when off-loading and moving the cabinet:

- Always keep the packages in an upright position.
- Do not drop the equipment.
- Do not stack the pallets.

The cabinet is bolted to the shipping pallet and packed in a cardboard sleeve that is designed to protect it from mechanical and environmental damage. Further protection is provided by wrapping the equipment with a plastic sheet.

Before you accept the shipment ensure that the received package(s) correspond to the description shown in the delivery documentation and carefully examine the packing containers for signs of physical damage

3.2.1 REPORTING DAMAGE

Claims for shipping damage must be filed immediately when found, and the carrier must be informed of ALL claims within seven days of receipt of the equipment. If the equipment is to be stored for longer than seven days before it is installed, you should unpack it and inspect it for signs of internal damage before you put it into storage. Note that some optional equipment packages might be shipped inside the cabinet, and these too should be checked for damage.

If the equipment is damaged, you should store the packing materials for further investigation.

3.2.2 STORAGE

If you plan to store the ELMOD prior to its installation it should be kept upright (preferably in its original shipping packaging) in a clean, dry environment with a temperature between -25°C to +60°C and RH <93%.

If the storage period is likely to exceed seven days, the packaging should be removed, and the cabinet inspected for shipping damage before it is placed into storage. If there is no apparent damage you should refit the packaging or cover the cabinet with a dust-cover to prevent the ingress of dust and dirt.

Batteries that are intended for external rack-mounting will be shipped in a separate package and should be stored under the environmental conditions stipulated above.

3.2.3 UNPACKING INSTRUCTIONS



WARNING: The cabinet, battery cabinet (optional) and battery packages are heavy and may tip during unpacking unless the unpacking instructions are not followed closely.

If the shipment is received in good order, please unpack the ELMOD cabinet as follows:

1. Remove the plastic sheeting and cardboard sleeve covering the cabinet.
2. Remove the anchor bolts securing the cabinet to the pallet then lift and remove the cabinet from the pallet.
3. Retain the packaging materials for possible future shipment.
4. Examine the cabinet for any sign of damage and notify your supplier immediately if any damage is found.
5. Remove any internal protective packaging.
6. When the cabinet is placed in its final location, install the 4kVA power modules and secure them in place.
7. Install a blanking plate to the front of any shelves that have no power module fitted.

Batteries



CAUTION: The system batteries must ALWAYS be installed by the commissioning engineer.



WARNING: If the system is delivered without batteries, Kohler Uninterruptible Power Ltd. will not accept responsibility for any damage or equipment malfunctioning caused by the incorrect storage, installation or connection of batteries carried out by third parties.

The batteries are shipped in a separate package and should remain in their packing until required by the Kohler Uninterruptible Power Ltd. service engineer when the system is commissioned.

Battery life depends very much on the ambient temperature, and optimum battery life will be obtained if the batteries are stored and operated at a temperature of 20°C.

3.3 INSTALLATION

3.3.1 ENVIRONMENTAL CONSIDERATIONS

A certain amount of pre-planning will help provide a trouble-free installation process. You should consider the following guidelines when planning the installation location and operating environment.

1. The route to the installation location must allow the equipment to be transported in an upright position.
2. The floor at the proposed installation site and en-route from the off-loading point must be able to safely support the weight of the cabinet/battery equipment, plus fork lift or trolley jack during transit.
3. The cabinet requires sufficient front and rear clearance to enable cooling airflow, as described below.
4. All maintenance, servicing and user operation can be carried out from the front of the cabinet, but rear access is required for connecting the AC and DC power cables.
5. An ambient temperature of 20°C is necessary to achieve the recommended battery life span.
6. The cooling air entering the cabinet must not exceed +40°C.
7. The floor material should be non-flammable and strong enough to support the heavy load.

In summary, the system should be installed in a location where:

© 2025 Kohler Uninterruptible Power

- a) Humidity (< 93%) and temperature is ideally 20°C.
- b) Fire protection standards are respected.
- c) Cabling can be performed easily.
- d) A minimum 600mm front accessibility is available for service or periodic maintenance.
- e) Adequate cooling air flow is available.
- f) The air conditioning system can provide a sufficient amount of air cooling to keep the room at, or below, the maximum desired temperature (where used).
- g) No dust or corrosive/explosive gases are present.
- h) The location is vibration free.

3.3.2 CLEARANCES

Cooling air enters the front of the power modules and force ventilate through the cabinet rear.

- A. You should provide a minimum of 600mm clearance at the front of the cabinet to allow the power module(s) to be removed/installed.
- B. You should provide a minimum of 300mm at the rear of the cabinet and 700mm above the cabinet.
- C. The cabinet does not require any side clearance for cooling purposes so it can be installed immediately adjacent to another cabinet, battery enclosure or wall; however rear access is necessary for cabling purposes.

The battery installation is bespoke, and specific access clearances will be specified by the battery installation designer.

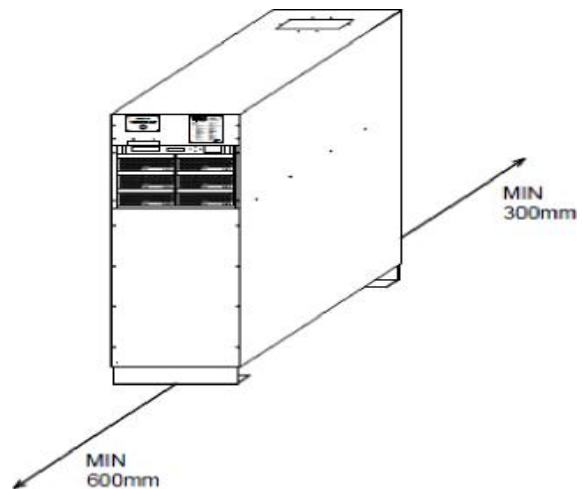

3.3.4 CABLE CONSIDERATIONS

It is the customer's responsibility to design and install the ELMOD supply and distribution circuits, and provide all the external fuses, switchgear and cables required to connect the cabinet's AC INPUT, DC INPUT and SI OUTPUT supplies. The information provided in this section should assist you in the planning and preparation of the power cabling.

The AC INPUT terminals should be connected to a utility mains LV-switchgear panel and protected by a circuit breaker or fused isolator. The protective device not only offers overload protection but also provides a means of disconnecting the mains supply from the ELMOD, as there is no input supply switch fitted to the standard cabinet.

A fused battery isolator must be fitted inside the external battery cabinet – or immediately adjacent to the battery installation if a purpose-designed battery cabinet is not used. This requires a three-pole device, connected to the battery positive, negative, and mid-point (neutral), as shown. Kohler Uninterruptible Power Ltd. can supply a matching battery cabinet containing the necessary fuses and switchgear.

Similarly, the SI OUTPUT terminals should be connected to the load equipment via a suitably protected load distribution panel.

The recommended output circuit breakers are specified in the following table.

QTY OF MODULES	OUTPUT DEVICE TYPE						
	B4	B6	B10	B16	C10	C16	C20
1	YES	NO	NO	NO	NO	NO	NO
2	YES	YES	YES	NO	NO	NO	NO
3	YES	YES	YES	YES	YES	NO	NO
4	YES	YES	YES	YES	YES	NO	NO
5	YES	YES	YES	YES	YES	YES	NO
6	YES	YES	YES	YES	YES	YES	YES

Table 3.1

3.3.5 INRUSH CURRENT

Special Consideration should be taken when installing luminaires with very high inrush characteristics.

The Inrush Current of LED Luminaires is determined by the driver (s) and is not proportional to the luminaire wattage or running current, LED luminaire inrush currents can be as high as 400 times the running current for a very short period of time.

Further information regarding LED inrush currents can be found by accessing the “LIA Technical Statement LIA TS35” from the LIA website (www.thelia.org.uk).

The table below provides some details regarding the maximum recommended inrush currents for luminaires:

QTY OF MODULES	Maximum Inrush Current
1	35A
2	70A
3	105A
4	140A
5	175A
6	210A

If higher inrush levels are expected Kohler Uninterruptible Power Ltd can provide Inrush Current Limiter for LED lighting Drivers.

Rated at maximum 16A continuous power they can be installed within lighting distribution panels.

3.3.6 CABLE SPECIFICATION

All cables and protective devices must be selected in accordance with national and local regulations and codes of practice (e.g. BS7671:2008 or relevant country standards) to suit the maximum capacity of the system, as shown in the table below.

NOTE: If you install a system containing fewer than six power modules with a view to increasing the system capacity it at a later date as your load increases, you should consider using cables rated for the maximum system rating at the outset. This will simplify the future update process and avoid having to shut-down the system at a later date to replace the power cables. ALL power modules have internal fuse protection

NOTE: Input Maximum Current includes 120% load @ 230V and charger at max %.

ELMOD 1:1 & 3:1						
	1 MOD 4kVA	2 MOD 8kVA	3 MOD 12kVA	4 MOD 16kVA	5 MOD 20kVA	6 MOD 24kVA
INPUT						
Maximum Current	26	52	78	104	130	156
OUTPUT						
Maximum Current	19.2	38.4	57.6	76.8	96	115
BATTERY						
Maximum Current	12	24	36	48	60	70
GROUND						
Suggested Cable Size mm ²	10	10	25	35	50	70

Table 3.2

3.3.7 ELECTRICAL PLANNING

All electrical power connections are made to terminals located on the rear of the cabinet near the top. Gland plates are fitted to the top and bottom of the cabinet immediately above the power terminals to allow either top or bottom cable entry.

If the cabinet is to be installed in a location with restricted rear access, you should ensure that suitably-contained power cables are available before the cabinet is moved to its intended final position

3.3.8 CABLINING PROCEDURE

3.3.8.1 SAFETY NOTES

Please ensure you read and understand the following safety notes before you begin the electrical installation.

1. All the operations detailed in this section must be performed or supervised by a qualified, authorised electrician.
2. Once the electrical installation is completed the initial system start-up must be performed by a qualified engineer, trained and authorised by Kohler Uninterruptible Power.
3. Do not connect the system if there is water or moisture present.
4. When working on the input power cables, you must ensure that the AC INPUT supply is isolated at the mains switchgear panel and, where possible, locked out. Warning notices should be posted where applicable to prevent the inadvertent operation of the LV supply isolator(s).
5. Ensure the following conditions are met prior to starting work on the equipment:
 - a) No mains voltage is present from the mains switchgear panel.
 - b) All loads are shut down and disconnected.

3.3.8.2 TERMINAL CONNECTIONS

4kVA TERMINATIONS

Terminal connections can be found at the FRONT TOP of the cabinet as per figure 3.1A.

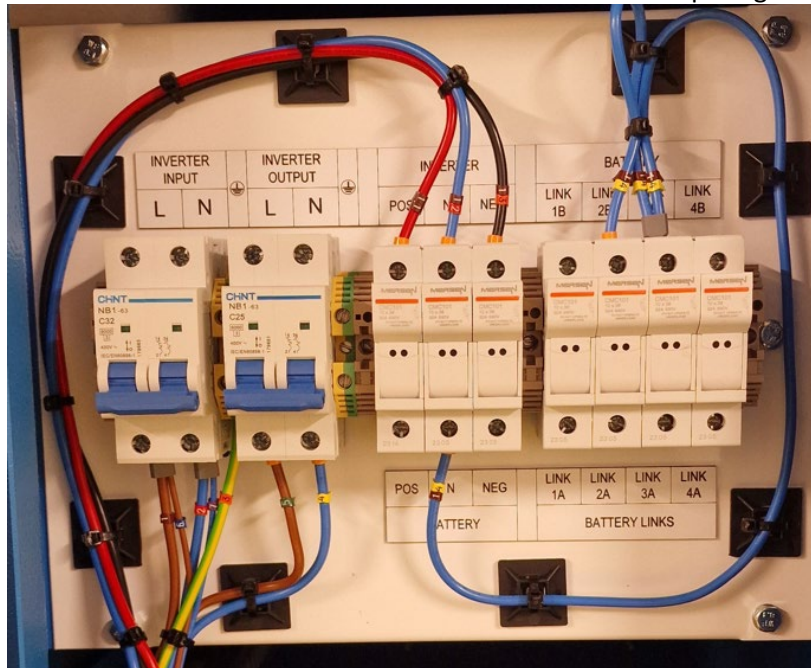

Figure 3.1A

8 – 24kVA TRMINATIONS

Terminal connections can be found at the rear of the cabinet as per figure 3.1B.



Figure 3.1B

Input Cables

1. For a single-phase input supply:

- a) Fit link bars to the AC INPUT terminals L1, L2, L3



And the three Neutral (N) terminals,



- a) Connect an earth cable between the utility supply earth and terminal PE.
- b) Connect the utility supply live cable to the (linked) AC INPUT terminal.
- c) Connect the utility supply neutral cable to the (linked) N terminal.
- d)

Output Cables

1. Fit a link bar to the UPS OUTPUT terminals L1, L2, L3.



2. Connect the protective earth cable from the load distribution board to the protective earth PE terminal.
3. Connect the output supply live cable to the (linked) UPS OUTPUT terminal.
4. Connect the output supply neutral cable to the (linked) N terminal.

Battery Cables

The DC cabling for the battery system(s) must be completed by an Kohler Uninterruptible Power Ltd. engineer or one of its approved service agents. The customer installation team is only responsible for providing any necessary containment for the DC cables.



WARNING: Do not attempt to fit the batteries, complete the battery wiring, or close the battery isolator

CHAPTER 4 – OPERATION INSTRUCTIONS

4.1 START UP

Note: When you turn on the ELMOD system its initial operating mode depends on the working conditions that were present when the system was previously shut down. This procedure covers the complete sequence of actions required to turn on the system from a fully powered-down state and then select the wanted operating mode.

1. Turn on the input mains supply:
 - a) The cooling fans will operate.
 - b) The red alarm led (ALM) will illuminate on every power module.
 - c) The green RUN led will flash on every power module, accompanied by the sound of clicking relays, as the modules run through their start-up checks.
 - d) The audible alarm will sound. This can be cancelled by pressing the Esc key.

2. As each power module completes its start-up checks the green RUN led on the front of the module will change from flashing to solid green. This may take around two minutes to complete for all the power modules.

3. When the RUN led is fully illuminated on every power module, close the battery fuses/breaker:
 - a) The ALM led should extinguish on every power module.
 - b) If the ALM led does not extinguish, the control system has detected a fault – refer to the alarms identification and troubleshooting information.

4. When the system is first powered up, its operating state can be either ON or OFF depending on the conditions that were present when the unit was powered down. You can change the current operating state by selecting menu 5.1 in the SETUP menu.
 - a) If the top line in menu 5.1 shows [5.1 SYSTEM OFF] it indicates that the system is currently ON and you can turn it OFF by pressing the Ent key twice.
 - b) If the top line in menu 5.1 shows [5.1 SYSTEM ON] it indicates that the system is currently OFF and you can turn it ON by pressing the Ent key twice.

5. When the system is first powered up, its operating mode will be the same as it was when the unit was powered down.
You can view and change the current operating mode by selecting menu 5.4 in the SETUP menu. The top line in menu 5.4 shows [5.4 WORK STYLE] and the second line shows the currently selected mode – either CHANGEOVER, INVERTER, or NON-MAINTAINED:
 - a) If you want to change the operating mode, select it using the UP and DOWN scroll keys, then press Ent.
 - b) Observe the system output voltage using menu 1.2.
 - c) If the output voltage is correct, close the output circuit breakers to connect power to the emergency luminaires.
 - d) The ELMOD is now fully operational.
 - e) With the system now running, the input, output and battery operating parameters can be monitored at any time using the Control Panel menus as described on page 13.

4.2 SHUT DOWN

1. Open the output circuit breakers to disconnect the supply to the emergency luminaires.
2. Open the battery fuses/breaker:
 - a. The ALM led should illuminate on every power module accompanied by an audible warning alarm.
3. Turn off the input mains supply.

4. The ELMOD is now fully shut down.

4.3 POWER MODULE REMOVAL

1. Press The ON/OFF Button as indicated in Fig 2.5
2. The Green LED will turn OFF and the Red LED will turn ON
3. Rotate the Thumb Lock and extract the module.



4.4 POWER MODULE INSTALL

1. Push the Power Module Fully into its position
2. Rotate the Thumb Lock to lock into place.
3. The power module completes its start-up checks the green RUN led on the front of the module will change from flashing to solid green. This may take around two minutes to complete for all the power modules.

4.5 KEYSWITCH

The ELMOD Test key switch is located in top left-hand side of the system.

The Test switch is designed to test the function of the Static Inverter and directly connected emergency luminaires.

A key switch is used to interrupt the supply to the Static Inverter or luminaires for a pre-programmed period of time. At the end of the selected time period, the supply to the static Inverter or luminaires is automatically re-instated. The result is that there is no risk of depleting the batteries in the Static Inverter or emergency fitting.

Three pre-programmed test intervals are available:

- 10 minutes
- 1 hour
- 3 hours

The test switch will power up with the **SUPPLY ON** lamp illuminated

Turn and release the key switch to select the 10-minute test interval. Turn and release again to select the next test interval—the supply will be dis-connected from the output for the duration of the test.

To cancel a test, turn and release the keyswitch until the **SUPPLY ON** lamp illuminates.

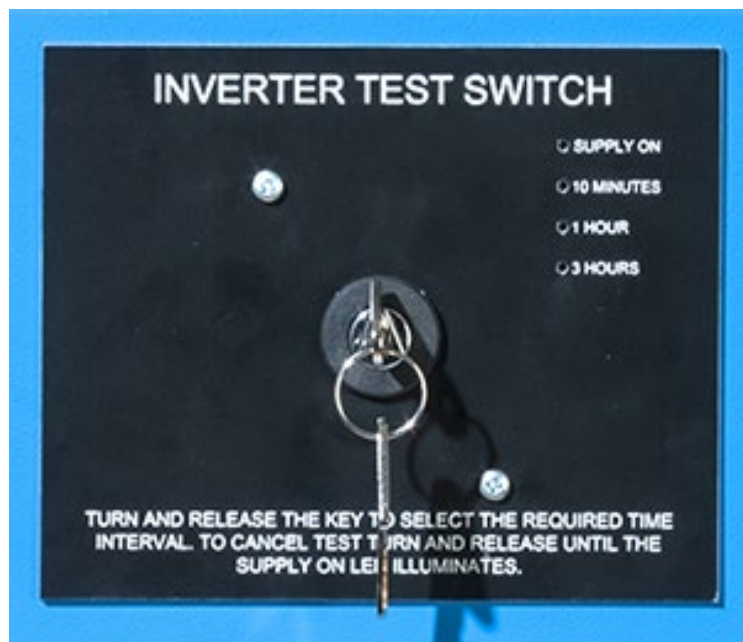

CHAPTER 5 – MAINTENANCE INSTRUCTIONS

The ELMOD does not contain any user-serviceable parts, so day-to-day maintenance requirements are minimal other than to ensure that the operating environment is kept cool and dust free. A clean operating environment will help maximise the useful working life and reliability of both the ELMOD and its batteries.

5.1 EMERGENCY LIGHTING MAINTENANCE

The ELMOD system should be maintained as per the regulations set out in EN50172 Standards:

- Log Book Should be kept on site indicating all testing / inspection reports as detailed within the standard
- Daily – Indicators of central power supply should be visually inspected for operation
- Monthly – All luminaires and exit signs should be put into test and transferred to the central battery supply. The Central Battery system should be put into test and all luminaires checked for operation.
After return to normal operation the central battery system should be checked for normal operation.
- Annually – The specific Monthly test should be conducted for the full duration of the system. After restart the charging of the batteries should be fully checked for operation. Certificate / Test sheet should be recorded within the logbook.

5.2 SCHEDULED MAINTENANCE

It is essential that the ELMOD cabinet and batteries receive regular preventative maintenance to maximise both the useful working life and system reliability. When the system is commissioned, the commissioning engineer will leave a service record book with the customer that will be used to log its full-service history.

We recommend that the system is maintained every Twelve months (visit frequency should be increased dependent on environment conditions) by an Kohler Uninterruptible Power Ltd. Trained engineer, or approved service agent, who will complete the following:

5.2.1 Preventative maintenance inspection

Preventative maintenance inspections form an integral part of all Extended Warranty Agreements (maintenance contracts) offered by Kohler Uninterruptible Power Ltd.

During a preventative maintenance inspection, the engineer will check and validate:

- Site environmental conditions
- Integrity of electrical installation
- Cooling airflow
- Load characteristics
- Integrity of alarm and monitoring systems
- Operation of all installed options.

5.2.2 Battery maintenance and testing

The battery installation should be inspected on a regular basis, not exceeding 12-months. Traditional VLRA battery testing and maintenance consists of:

- Checking and recording the open-circuit battery voltage
- Verifying that the float charging voltage is correct
- Inspecting all battery terminals and connections for corrosion
- Inspecting all batteries for cracks, leaks or swelling
- Checking the integrity of the inter-cell connections
- Removing any materials and cleaning around the equipment
- Carry out a full battery check.

CHAPTER 6 – TROUBLE SHOOTING

The ELMOD will generate an audible warning if a fault or abnormal operating condition is detected and indicate the source of the alarm trigger on the LCD panel.

If the alarm is generated by a fault within a power module the red alarm (ALM) led will illuminate on the front of the affected module to identify the module at fault. If the alarm is not specifically due to a module fault (e.g. input supply failure) the module ALM LED(s) will remain OFF.

There are no user-serviceable parts in the ELMOD cabinet, so the degree of rectification that can be carried out by the operator is minimal, apart from ensuring that the system's AC and DC power supplies are available and within specification, and the load connected to the UPS OUTPUT is within the cabinet rating.

An internal fault can usually be attributed to a faulty power module, control panel or an ancillary assembly such as the cooling fan, all of which require the attention of a trained engineer who will exchange the faulty assembly in most instances.

From an operator perspective, if you encounter a system malfunction or alarm condition you should do the following:

1. Silence the audible warning by pressing the Esc key.
Note that the alarm cannot be silenced if a FAULT condition is still present.
2. If an Alarm (ALM) led is lit on one power module only (i.e. not illuminated on all modules) then seek immediate advice from your nearest service centre.
3. Scroll through the ALARMS sub-menu shown in Table 6.1 and record the presented alarm and status data.
4. Interpret the alarm and status data following the tables shown below and seek assistance from your nearest service centre if the cause of the alarm is beyond simple rectification.

6.1 ALARM TABLE

ALARM	SUGGESTED SOLUTIONS
BAT ANOMALY	<ol style="list-style-type: none"> 1. Check the direct current and voltage of the monitor overview screen is normal 2. Check the positive and negative isolator is turned on 3. Check the DC voltage at the battery positive and negative terminal are correct.
BYP ANOMALY	<ol style="list-style-type: none"> 1. Check the AC incoming isolator is turned on 2. Check the 3-phase voltage of the AC input isolator is normal 3. Check the 3-phase voltage of the Inverter AC terminal is normal
MAIN ANOMALY	<ol style="list-style-type: none"> 1. Check the AC incoming isolator is turned on 2. Check the 3-phase voltage of the AC input isolator is normal 3. Check the 3-phase voltage of the Inverter AC terminal is normal
INV ANOMALY	<ol style="list-style-type: none"> 1. Check the AC output isolator is turned on 2. Check the 3-phase voltage of the AC output isolator is normal 3. Check the 3-phase voltage of the Inverter AC output terminal is normal
PHASE ANOMAL	1. Check Phase rotation of incoming supply
PRE LOAD	Check if there is overload in the system
OVER LOAD	Check if there is overload in the system
OUTPUT SHORT	<ol style="list-style-type: none"> 1. Check if there is short in the load 2. Check if there is short in the output terminal
BAT SUPPLY	Check whether the AC input is abnormal
ON-LINE	Information notes only
MAIN RESTORED	
BYP RESTORED	
BAT RESTORED	
INV RESTORED	
PHASE OK	
COMMUNI OK	
OP REJECTED	
MODE CHANGE	
OUT BREAK	
EQUA CHARGE	
FLOT CHARGE	
SYSTEM ON	
PARAM CHANGE	
BY-PASS	
SYSTEM OFF	
EPO WARN	
COMMON FAULT	
FAN FAULT	
MOD ALARM	

CHAPTER 7 – COMMUNICATION

7.1 INTRODUCTION

The ELMOD system offers a range of interfaces that can be connected to external facilities management and monitoring systems. All the interface connections are located on the system control panel as illustrated previously in Figure 7.1. The terminal blocks, RS232/RS485 and RJ45 connectors are protected by a removable cover plate which is secured to the cabinet top panel by two screws. The SNMP card slot is fitted with a separate cover plate.

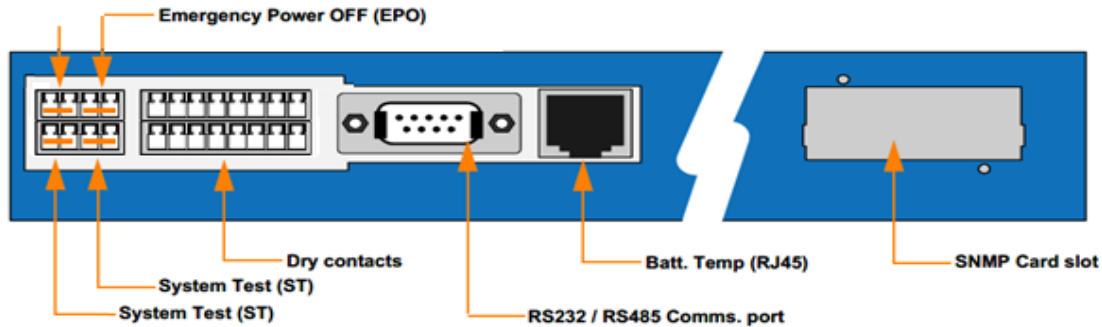

Figure 7.1

7.2 TERMINAL BLOCK CONNECTIONS

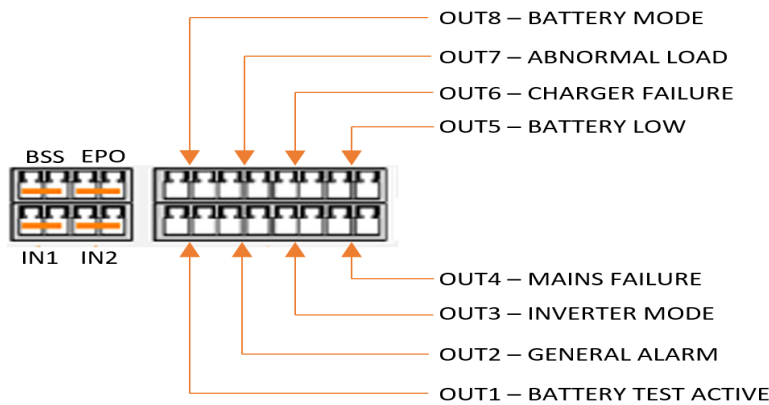

Figure 7.2

7.2.2 EMERGENCY POWER OFF

An external EPO circuit can be connected to the two left-most terminals on the 4-way terminal block. The external circuit must be 'normally closed' to effectively short-circuit the EPO terminals. If the EPO circuit is operated (open-circuit) the ELMOD will shut-down and disconnect the load power.

The EPO terminals are volt-free and should be connected using a screened cable with 1 pair (0.5 mm²) and maximum length of 100m.

Note: If an external EPO circuit is not connected, a shorting link must be connected to the EPO terminals (as shown).

7.2.3 IN1 & IN2

NOTE: INPUT1 used for the key-switch as detailed in Section 4.4

INPUT 1 and INPUT 2 can be changed to provide 4 different functions:

MANUAL BYPASS

If external Maintenance Bypass Switch is installed, auxiliary can be connected to this section. In normal operation input should be NO, on contact closure system is forced to Bypass Mode.

When released system automatically transfers back to Normal Operation.

UPS OFF

Contact should be Normally Closed in Normal Operation.

If contact is Closed Inverter is turned off fully and system is forced to Bypass Mode.

© 2025 Kohler Uninterruptible Power

When released system automatically transfers back to Normal Operation.

EQUALISATION CHARGE

Contact should be Normally Closed in Normal Operation.

If contact is opened the charger forces the DC voltage to the selected equalization charge voltage.

This is held for 10 hours even if the contact is changed to Normally Open.

BATTERY TEST

The battery test facility is used to test the ELMOD operation on battery power the two Input (IP) terminals must be normally closed. In this case, if the connection between the IP terminals goes open-circuit it turns off the rectifier and the load is operated from the inverter using the standby battery power.

The Battery test function can be connected to a local or remote operating device (switch). The Battery Test terminals are volt-free and when using a remote test facility, they should be connected using a screened cable with 1 pair (0.5 mm²) and maximum length of 100m.

Note: If an external Battery Test circuit is not required, a link must be fitted to the IP terminals, or none selected for the input selection.

7.2.4 DRY PORT CONTACTS

The ELMOD provides eight hard-wired 'system status' outputs that can be used to drive remote signalling and/or monitoring facilities. These output are switched by volt-free relay contacts and are normally closed (open on activation). The contacts are rated for 24VDC @ 0.5A.

As shown in Figure 7.2, the eight switched alarm outputs are:

- **OUT 1 – BATTERY TEST ACTIVE**
IN1 or IN2 are selected as "Battery Test", changes state to NO when battery test is activated.
Not Activated during a Mains Failure
- **OUT 2 – GENERAL ALARM**
Changes state to NO on any internal alarm including Mains failure.
Not activated during a Battery Test from IN1 or IN2
- **OUT 3 – INVERTER MODE**
Changes state to NO if Output is being fed from Inverter.
- **OUT 4 – MAINS FAILURE**
Changes state to NO if the input voltage or frequency is out of tolerance
Not activated during a Battery Test from IN1 or IN2
- **OUT 5 – BATTERY LOW**
Changes state to NO if the battery voltage goes below its set value
- **OUT 6 – CHARGER FAILURE**
Changes state to NO if any of the modules indicates a charger fail alarm
- **OUT 7 – ABNORMAL LOAD**
Changes state if the total system load is over 100%
- **OUT 8 – BATTERY POWER**
Changes state to NO if the load is being fed from the Battery Source and not the mains.

All Dry Port Alarms are designed to be FAIL SAFE Operation. Dry ports are in NO state when the System is deactivated. When the system is running in Normal Operation all alarms are NC
Alarm changes state to NO on activation of Alarm.

Connections to these terminals should be made using a screened cable with 1 pair (0.5 mm²) and maximum length of 100m.

7.3 BATTERY TEMPERATURE SENSING

The battery temperature can be measured by a thermocouple sensor that is attached to the battery and connected to the RJ45 connector on the front of the ELMOD via a purpose-designed adapter.

The temperature sensing signal is monitored by the battery charger control system to provide a temperature-compensated battery charging profile and also provides a battery temperature indication on the control panel menu.

7.4 SNMP CARD SLOT

Simple Network Management Protocol (SNMP) is a world-wide, standardised communication protocol that can be used to monitor any network-connected device via a simple control language and display the results in an application running within a standard web browser.

An SNMP card slot, designed to house a Modem/Ethernet SNMP adapter card, is located behind a cover plate on the right-hand side of the control panel. To fit the card, you must remove the cover plate, insert the card into its connector then secure it in place using the screws that you removed when taking off the cover plate.

The SNMP adapter card contains an RJ-45 Ethernet connector which allows the ELMOD to be connected to a network using a standard CAT-5 network cable. Once connected, the system management software agent that is preinstalled in the SNMP adapter monitors the ELMOD operation and outputs its data in SNMP format to the connected network.

The communication exchanged between the ELMOD and network enables event/alarm emails, server shut down (with optional licenses) and other tasks to be performed. It can also be integrated with BMS software over a local area network (LAN) for SNMP.

The SNMP adaptor requires a PC with terminal connections, and for normal operation at least one Ethernet connection.

Note: SNMP connectivity can also be implemented using an external SNMP adapter connected to the RS232 output.

CHAPTER 8 – TECHNICAL SPECIFICATION

8.1 EL POWER MODULE TECHNICAL SPECIFICATION

Model	ELM-04
Capacity	4KVA
Input / Output mode	1/1
Input PF	≥ 0.99
THDI (%)	≤ 3%
Overload ability	Comply to system overload requirement
Charging power	1600W
Weight (kg)	7

8.2 ELMOD SYSTEM TECHNICAL SPECIFICATION

Single Phase Input	
MAINS INPUT	
Input Mode	1-phase +N +E
Input voltage	220V / 230V / 240V ±25%
Input frequency	50Hz±10%, 60Hz±10%
Input Current	Refer to table 3.2
Power woke-in (Sec.)	60secs
THDI (%)	< 3%
Input PF	≥ 0.99

Single Phase Input	
BYPASS INPUT	
Input Mode	1-phase +N +E
Input voltage	220V / 230V / 240V ±25%
Input frequency	50Hz±4%, 60Hz±4%

DC INPUT	
Rated Input voltage	±240VDC
Input voltage tolerance	±216V~±246VDC

BATTERY CHARGING	
Charging current limited	YES
Charging ability	12 hours (3 hours back up)
Stability of charging voltage	±1%

AC OUTPUT

UPS power factor	0.9
Output voltage	220,230,240VAC
Output frequency	±4%; ±0.2%(battery supply)
Output voltage stability	±1%
Output voltage recovering time	20ms (load 0~100% change)
Output Current	Refer to table 3.2
Overload ability	120% Continuous, 150% for 10mins, 175% for 1 min
Transfer from mains to battery	0ms
Transfer from bypass to	<1ms
Peak factor	3:1
Waveform distortion	≤ 1% (linear load), ≤ 3%(non-linear load)
Overall efficiency	≥ 93% (AC~AC), ≥ 98% (DC~AC)
Load share precision	≤5%
Output Short Circuit	3 x Output Current for 120ms

ENVIRONMENTAL

Ambient temperature	-25°C ~ 60°C
Operating temperature	-5°C ~ 40°C
Maximum operation altitude	≤ 1500m
Relative humidity	≤ 95% non-condensing
Protection degree	IP30
Cooling	Air cooling
Applicable safety standards	EN62040-1-1:2003 IEC60950-1:2001
Electromagnetic compatibility	EN62040-2:2006
Acoustic noise	≤ 55DB
Heat Dissipation	Changeover Mode = 120W per module Inverter Mode = 280W per module

OTHERS

Interface	RS232, RS485, 2 dry contact, TCP/IP
Display	LCD/LED
4kVA Dimension (mm)	W900 x D750 x H1685
8-24kVA Dimension (mm)	W510 x D850 x H1340
4kVA Weight	250kgs per cabinet +7kg per module fitted
8-24kVA Weight	100kgs per cabinet +7kg per module fitted