

KOHLER®

UNINTERRUPTIBLE
POWER



KOHLER *MINIpowerPLUS*

Modular single-phase uninterruptible power supply

(1.25 kVA to 10 kVA)

User Manual

Document Control	1
Useful Contacts	1
1: General Description	3
1.1 Reliability and Quality Standards	3
1.2 MINpowerPLUS Model Range	3
1.3 Operating Principles	4
1.4 Warranty	7
1.5 Extended Warranty	7
1.6 Additional Service/Maintenance Support	7
2: Safety	1
2.1 Description of symbols used in this manual	1
2.2 User precautions	1
3: Installation	2
3.1 Introduction	2
3.1.1 Receipt of the UPS	2
3.1.2 Site transportation	3
3.1.3 Unpacking the UPS	3
3.1.4 Batteries	3
3.1.5 Storage	3
3.2 Planning the Installation	4
3.2.1 MINpowerPLUS Tower versions	4
3.2.2 MINpowerPLUS Rack-mounted versions	5
3.2.3 Environmental considerations	5
3.3 UPS Installation Procedure	6
3.3.1 Connect the UPS cabinet to the battery cabinet	6
3.3.2 Connecting the UPS communication options	8
3.3.3 Connect the UPS input/output power cables	9
3.3.4 Powering ON the UPS	12
4: Operation	13
4.1 Operating Instructions	13
4.1.1 Standard installation without the maintenance bypass option fitted	13
4.1.2 Installation with Maintenance Bypass option fitted	13
4.2 Control Panel	15
4.2.1 Alpha-numeric LCD Display	15
4.2.2 Operator Keypad	16
4.3 Alarms and Indications	16
4.4 UPS Customisation and Event Monitoring Menus	17
4.4.1 Main Menu	17
4.4.2 UPS Status Menus	18
4.4.3 UPS Setup Menu	19
4.4.4 Events Menu	22
4.4.5 Scheduling Menu	23
4.4.6 Tools Menu	24
4.5 Diagnostic Software	24
5: Maintenance	25
5.1 Introduction	25
5.2 Routine maintenance	25
5.3 Battery Testing	25

6: Troubleshooting	26
6.1 Potential Problems and Solutions	26
7: Options	27
7.1 Maintenance Bypass	27
7.1.1 Introduction	27
7.1.2 Installation	28
7.1.3 Functional testing	29
7.1.4 Maintenance bypass specification	30
7.2 Shutdown and Monitoring Software	30
7.2.1 Introduction	30
7.2.2 WAVEMON UPS monitoring software	30
7.2.3 SNMP ADAPTER for network management/remote monitoring	32
7.3 PowerREPORTER™ management software	33
7.3.1 Relay Interface Board	34
8: Specifications	35
8.1 Construction Features	35
8.2 Environmental	35
8.3 Electrical Input	36
8.4 Output Waveform	36
8.5 Output When Running on Mains Power	36
8.6 Output When Running on Battery Power	37
8.7 Battery Operation (MINIpowerPLUS 5000)	37
8.8 Battery Operation (MINIpowerPLUS 10000)	37
8.9 Bypass	38
8.10 Reference Standards	38

1

General Description

1.1 Reliability and Quality Standards

Congratulations on your purchase of the MINIpowerPLUS UPS.

The MINIpowerPLUS UPS incorporates the latest technological advances in power engineering to offer a highly reliable, upgradeable UPS system with excellent electrical performance and low running costs.

Kohler Uninterruptible Power are leading specialists in the provision, installation and maintenance of UPS systems; and this compact and powerful UPS is just one example of our wide range of state-of-the-art power protection devices able to provide your critical equipment with a reliable power supply for many years.

The criteria and methods used in the design, manufacture and maintenance of this UPS system are certified to International Standard ISO 9001/EN 29001 and ISO 14001.

A full equipment specification is provided in Chapter 8 of this manual.

1.2 MINIpowerPLUS Model Range

The MINIpowerPLUS system is available in two model ranges.

MINIpowerPLUS 5000

The MINIpowerPLUS 5000 is available in both Rack-mounted and Tower versions and uses up to four 1250VA power modules to offer a system output rating of 1250VA, 2500VA, 3750VA or 5000VA.

Each power module requires three batteries which are housed within the UPS cabinet to provide a completely self-contained UPS system.

An optional external battery cabinet can be connected to the UPS to extend the system's autonomy time if required.



Figure 1.1 MINIpowerPLUS 5000

MINIpowerPLUS 10000

MINIpowerPLUS 10000 uses between four and eight 1250VA power modules to offer a system output of 5000VA, 6250VA, 7500VA, 8750VA or 10000VA.

In this model range the batteries are contained in a separate battery cabinet which is similar in design and appearance to the UPS cabinet and is usually positioned adjacent to the UPS cabinet to form a matching suite.

If required, additional battery cabinets can be connected to the existing battery cabinet to extend the system's autonomy time.



Figure 1.2 MINIpowerPLUS 10000

*MINIpowerPLUS 5000 (Rack and Tower) cabinets
Fully populated with 4 Power Modules to offer a
5.0kVA system.*

*Batteries are housed
within the UPS
cabinets.*



*MINIpowerPLUS 10000
Fully populated with
8 Power Modules to
offer a 10kVA system.
Batteries are housed
in a matching battery
cabinet.*

Figure 1.3 MINIpowerPLUS Power module usage

If a system is purchased without the maximum number of power modules fitted, additional modules may be fitted in the field (up to the limit of 4/8 modules) to expand the system up to full capacity; however this requires the UPS to be shut down while the additional module(s) and batteries are fitted.

1.3 Operating Principles

The UPS has three main operating modes:

- Mains operation
- Battery operation
- Bypass operation

Mains operation

When the mains supply is present, the input voltage is filtered then rectified by the power factor correction stage. This optimises the use of the mains supply by making the power factor practically unity, and compensates for any input voltage fluctuations. The rectified output from the power factor correction stage is connected to the inverter where it is converted to a clean, sinusoidal output voltage with very low distortion.

The operation of the power factor correction stage is particularly important when operating with very low loads. For example, with a nominal load of around 50% it is possible to sustain the inverter operation with the input mains voltage as low as about 100V without reverting to battery power. This feature enables a more intelligent management of the switch-over to battery power and minimises battery use. During mains operation the battery is continuously charged by a dedicated battery charger circuit.

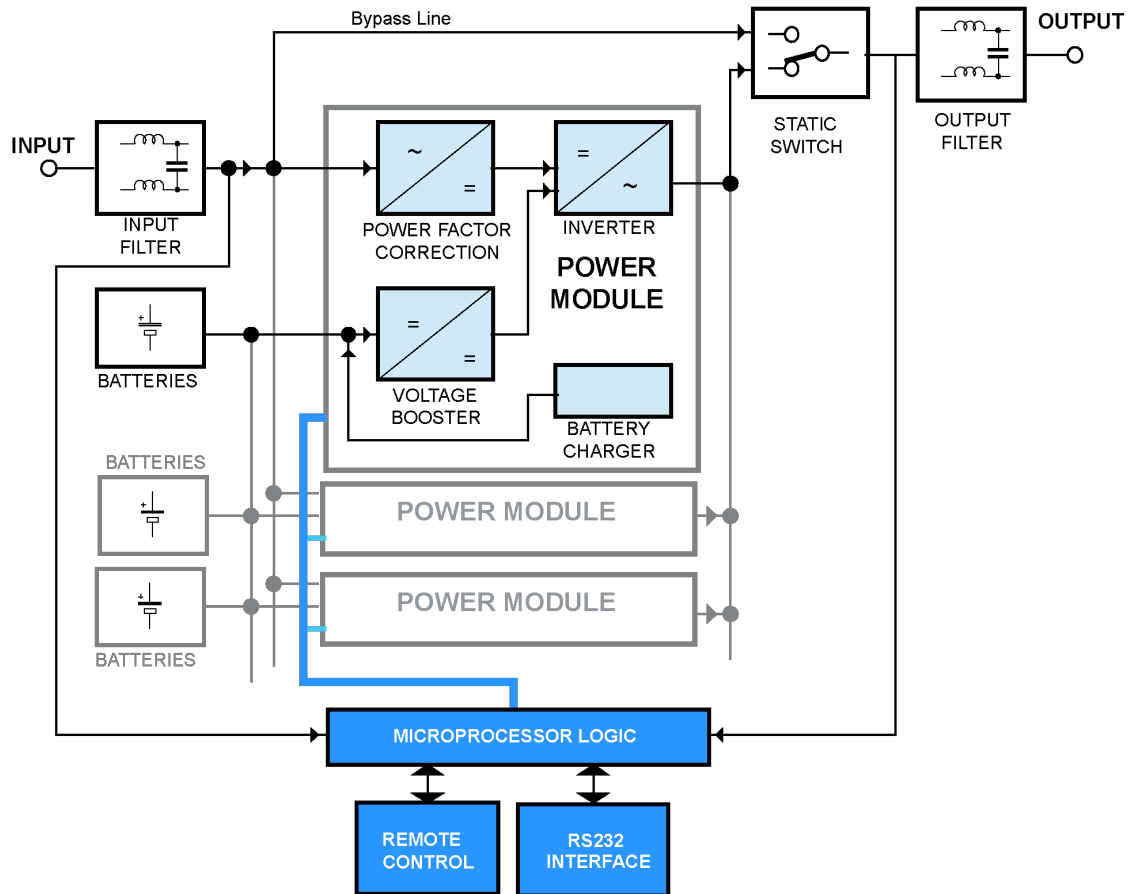

Figure 1.4 MINIpowerPLUS block diagram

A rapid, synchronised by-pass circuit is used to assist during overloads that exceed the inverter’s capacity – for example when certain peripherals that require a high start current are initially switched on.

The UPS power circuitry is a ‘passing neutral’ type: i.e. the mains supply neutral is common through to the inverter output. During normal operation, a sensor monitors the potential between the neutral wire and the earth wire and if it becomes excessive it:

- activates the input protection circuitry, which turns off the power factor correction stage
- switches the UPS to battery operation
- signals an error on the UPS control panel

Note: If preferred, the control software can be configured so that only an error signal is produced, without a switch-over to battery operation.

All the UPS operating functions are supervised in real-time by a microprocessor which controls and stores certain operating parameters in addition to managing an RS232 computer interface.

Battery operation

If the mains voltage fails, or is subject to excessive sag, the voltage booster stage activates automatically to provide an additional (or alternative) d.c. supply to the inverter. When this occurs the inverter input power source transfers seamlessly between the power factor correction stage and the voltage booster, and the inverter maintains the load supply without any power interruption.

The voltage booster stage obtains its power from the batteries, and when the UPS operates in this mode the operator is informed that the battery is 'on load' and therefore discharging, and a number of alarms activate at preset voltage levels as the battery discharges. The operating threshold and function of these battery alarms can be set by the operator through the UPS Setup menu to suit local application requirements.



Key Point: When the UPS is operating on battery, if the UPS mains supply cannot be restored the operator should arrange an orderly shutdown of the load before the UPS batteries reach a fully discharged state, whereupon the UPS is forced to shut down.

Bypass operation

When operating in the bypass mode the bypass circuit totally excludes the UPS and connects the UPS input supply directly to the UPS output.

The UPS automatically switches to bypass operation if:

- the UPS develops a fault which renders it unable to sustain the UPS output supply
- the UPS is shutdown for maintenance or repair purposes
- (momentarily) to assist the UPS handle an overload condition that exceeds the inverter rating

During normal operation the inverter is synchronised to the incoming mains supply, so that when a transfer to the bypass mode is required it takes place in a synchronised manner to prevent the risk of a power break or excessive voltage.

A dedicated bypass configuration menu provides a means of customising the by-pass circuit operation to meet specific application demands. This feature provides many options such as: 'automatic', 'disabled', 'by-pass in load waiting' mode.

1.4 Warranty

The MINIpowerPLUS UPS is supplied with a limited warranty that the UPS and its component parts are free from defects in materials and workmanship for a period of one year from the date of original commissioning, or fifteen months from the date of original delivery, whichever is the sooner. This warranty is the only warranty given and no other warranty, express or implied, is provided.

This warranty is invalidated if the UPS is used without having first been commissioned by a fully trained and authorised person. This warranty does not apply to any losses or damages caused by misuse, abuse, negligence, neglect, unauthorised repair or modification, incorrect installation, inappropriate environment, accident, act of God or inappropriate application.

If the UPS fails to conform to the above within the warranty period then Kohler Uninterruptible Power will, at its sole option, repair or replace the UPS. All repaired or replaced parts will remain the property of Kohler Uninterruptible Power

As a general policy, Kohler Uninterruptible Power does not recommend the use of any of its products in life support applications where failure or malfunction of the product can be reasonably expected to cause failure of the life support device or to significantly affect its safety or effectiveness. Kohler Uninterruptible Power does not recommend the use of any of its products in direct patient care. Kohler Uninterruptible Power will not knowingly sell its products for use in such applications unless it receives in writing assurances satisfactory to Kohler Uninterruptible Power that the risks of injury or damage have been minimized, the customer assumes all such risks and the liability of Kohler Uninterruptible Power is adequately protected under the circumstances



CAUTION: *The UPS system may contain batteries which must be re-charged for a minimum of 24 hours every six months to prevent deep-discharging. Batteries that have been, for whatever reason, deeply-discharged are not covered by the warranty.*

1.5 Extended Warranty

The Standard Warranty may be enhanced by protecting the UPS with an Extended Warranty Agreement (maintenance contract). An Extended Warranty Agreement enhances the standard warranty by providing:

- Regular preventative maintenance inspections
- Guaranteed speed of response to operational problems
- 24 hour telephone support
- Fully comprehensive (excluding batteries) cover

1.6 Additional Service/Maintenance Support

If you are interested in obtaining an extended warranty for your MINIpowerPLUS, or require service/maintenance support for any other UPS you may have, please contact Kohler Uninterruptible Power at the following address:

UK

www.kohler-ups.co.uk

Kohler Uninterruptible Power web site

ukservice.ups@kohler.com

Service department – booking service, fault reporting etc.

ukservicesales.ups@kohler.com

Extended warranty agreements etc

IRELAND

www.kohler-ups.ie

Kohler Uninterruptible Power web site

ieinfo.ups@kohler.com

Service department, technical queries, hardware sales and extended warranty agreements

2 Safety

2.1 Description of symbols used in this manual



WARNING: The warning symbol is used where there is danger of an electrical shock, equipment damage or personal-injury.



CAUTION: The caution symbol is used to highlight important information to avoid possible equipment malfunction or damage.

2.2 User precautions



WARNING: Keep this manual with the UPS for future reference.



WARNING: The UPS and peripheral equipment must be installed and commissioned by suitably qualified and trained personnel who are aware of the potential shock hazards.



WARNING: Do not attempt to install this UPS system until you are satisfied that ALL the safety instructions and hazard warnings contained in this manual are read and fully understood.



WARNING: High leakage current!
Ensure that the UPS has been correctly earthed before you connect the mains power supply!



WARNING: If the UPS is delivered without the batteries already fitted, it must not be powered up without having first been commissioned by an engineer authorised by the manufacturer.



WARNING: All servicing must be performed by an authorised engineer or other suitably qualified personnel. Do not attempt to service the UPS yourself.
You run risk of exposure to dangerous voltages by opening or removing the UPS covers! Kohler Uninterruptible Power will assume no responsibility or liability due to incorrect operation or manipulation of the UPS.



WARNING: MINIpowerPLUS is a Class A UPS product (according to BS EN 62040-2:2006). In a domestic environment the UPS may cause radio interference.
In such an environment the user may be required to undertake additional measures.



WARNING: The information contained in this manual is provided as a guide and is subject to change without notice for product upgrading.

3

Installation

3.1 Introduction

This chapter contains all the information necessary to enable you to correctly install the MINIpowerPLUS UPS, including unpacking, storage, positioning and cabling instructions.



WARNING: The electrical installation of this UPS system and its peripheral equipment must be carried out by an authorised electrician or other suitably qualified personnel.

Kohler Uninterruptible Power will take no responsibility for any personal injury or material damage caused by incorrect handling, cabling, operation, or other activities that are not carried out fully in accordance with the instructions contained in this manual.

Commissioning options

If the UPS is delivered with the batteries already fitted and connected, the system can be considered as being 'plug and play' and can be installed and powered ON by the user. However, if it is delivered without the batteries fitted, the cabinet(s) can be installed by the user but the batteries must be fitted and commissioned by a Kohler Uninterruptible Power approved engineer.

Note: The MINIpowerPLUS 5000 rack-mounted UPS is always shipped with the batteries fitted and connected.



WARNING: If the UPS is purchased and supplied without batteries, Kohler Uninterruptible Power will not accept responsibility for any UPS damage or malfunction caused by the incorrect supply, storage, installation or connection of batteries by third parties.

3.1.1 Receipt of the UPS

The UPS equipment, which includes the UPS Cabinet, batteries and accessories, are delivered on pallets that can be moved easily with the aid of a pallet jack. Before you accept receipt of the equipment ensure that the shipment is complete and the package(s) match the description shown on the delivery note.



CAUTION: When off loading the UPS equipment always keep it in an upright position. Do not drop the equipment or stack the pallets.

The UPS Cabinet is packed in a container designed to protect it from mechanical and environmental damage during transit. This protection is enhanced by wrapping and sealing the container in a polythene sheet.

Upon delivery you should carefully examine the packing containers for signs of physical damage. If there are signs of transportation damage you must inform both the carrier and Kohler Uninterruptible Power immediately.



Key Point: Claims for shipping damage that is discovered later when unpacking the equipment must be filed immediately when found. All damage claims must be reported to the carrier within seven days of receipt of the equipment.

If any shipping damage is discovered you should store all affected packaging materials for further investigation.



WARNING: Do not attempt to install or power-up damaged equipment.

3.1.2 Site transportation

When locally transporting the UPS equipment after it has been off loaded please observe the following cautions:



CAUTION: *If dropped, the weight of the UPS cabinet could cause serious injury to personnel or damage equipment in the surrounding area. Always handle with care. If the equipment is accidentally dropped do not connect it to the mains electricity supply.*

3.1.3 Unpacking the UPS

Note: Do not unpack the equipment if you intend to put it into storage prior to use (see paragraph 3.1.5).

Castors are fitted to the UPS Tower cabinet to enable it to be wheeled into position once it is unpacked. Before you remove a UPS Tower cabinet from its shipping pallet you should ensure that the floor surface is level and suitable for wheeling the cabinet into its final position. You should also ensure that the floor material can safely support the weight of the UPS equipment and batteries.

1. Remove any external polythene sheeting.
2. Remove the cardboard packing container:
Carefully cut through the securing bands then pull the container upwards.
3. Remove the protective polythene covering and any other packing from around the UPS cabinet.
4. Remove the fixings screws that secure the UPS feet to the pallet base, then carefully remove the UPS from the pallet.
5. Retain the packaging materials for future shipment of the UPS.
6. Examine the UPS for signs of damage and notify your carrier or supplier immediately if any damage is apparent.



Key Point: Before proceeding further with the installation process, check that the technical specifications on the nameplate located on the UPS back panel matches the purchased material detailed in the goods delivery note.

3.1.4 Batteries

The UPS uses sealed, maintenance-free batteries mounted on shelves within the UPS cabinet or housed in an external battery cabinet. Normally, the system is shipped with the batteries already installed and connected. If the batteries are ordered and shipped separately they must be fitted by a manufacturer-approved engineer as part of the system commissioning procedure.



Key Point: If the batteries are shipped separately, where possible it is preferable to leave them in their packaging until they are required for commissioning (see below for storage information).

3.1.5 Storage

UPS Cabinet storage

If you plan to store the UPS cabinet prior to installation it should be kept in a clean, dry environment with an ambient temperature between +5°C to +40°C and relative humidity of less than 90%.

Ideally the UPS cabinet should be stored in its original shipping packaging, but if it is removed from its packing container you must take measures to ensure it is protected from dust and humidity.

Battery storage

If shipped separately, the batteries should be stored in a dry, clean, cool environment and preferably in their original packaging. If the packaging is removed, the batteries must be protected from dust and humidity.

When stored, all batteries will self-discharge at a rate that is greatly affected by the ambient temperature. Batteries should therefore be fully charged before being put into storage and if they are to be stored for a long period they should be recharged periodically to prevent them from losing their original capacity. As a guide, the batteries should not be stored for longer than the periods shown below without being recharged:

- 6 months at 20°C
- 3 months at 30°C
- 2 months at 35°C



CAUTION: Sealed batteries must never be stored in a discharged or partially discharged state. The batteries can be destroyed by extreme temperature, under-charge, overcharge or over-discharge!

3.2 Planning the Installation

A certain amount of pre-planning will help ensure smooth, trouble-free installation. The following guidelines should be considered when planning a suitable UPS location and environment.

3.2.1 MINIpowerPLUS Tower versions

Cabinet positioning and accessibility

The MINIpowerPLUS 5000/10000 UPS Tower cabinet is compact and mounted on wheeled castors so that it can be easily moved to its intended operating location.

As shown in Figure 3.1 the UPS and battery cabinets require a minimum of 200 mm clearance at the rear and either side to permit adequate cooling airflow. However, in each case full rear access is required for cabling, and side access is necessary for maintenance and repair. For this reason it is recommended that the cabinets are located so that they can be wheeled forward to provide the necessary side and rear access when required.

This recommendation must be taken into consideration when cabling the equipment so that a sufficient cable length is provided to allow for the prescribed cabinet movement.

Figure 3.1 shows a space of 900 mm provided at the front of the cabinets. This allows adequate room for the safe passage of personnel during normal operation and also sufficient space for the cabinets to be pulled forward for access, as described above.

Note: Ensure that the cabinet is located in an area where the ventilation grills are unlikely to be accidentally covered.

Moving the UPS to its final location

- The flooring material where the UPS is to be located should be non-flammable and capable of safely supporting the weight of the UPS cabinet and battery cabinet (where used).
- The transit route must allow the equipment to be transported in an upright position.

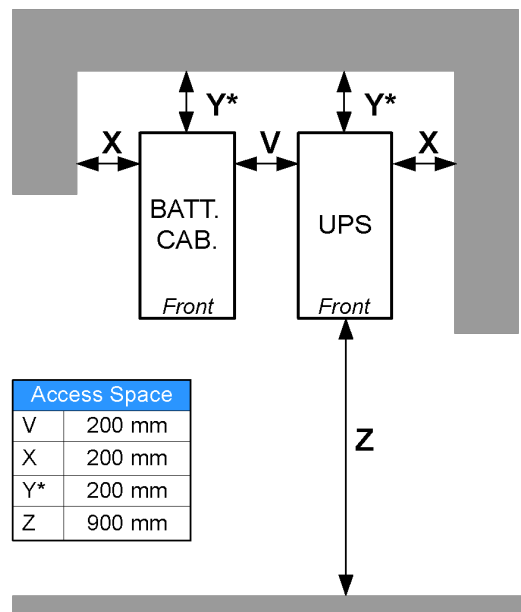

Figure 3.1 UPS Tower clearances

3.2.2 MINIpowerPLUS Rack-mounted versions

Rack positioning and accessibility

The MINIpowerPLUS Rack-mounted UPS cabinet is designed to fit into a standard 19 inch rack and is 6U high. The cabinet is fitted through the front of the rack, supported on suitable rails and secured in position by means of two screws on each side of the front of the assembly.

All MINIpowerPLUS 5000 Rack-mounted UPS cabinets also contain the UPS batteries; however a matching rack-mounted battery cabinet is available if an extended battery facility is required. Where used, the separate battery cabinet (also 6U) and UPS cabinet should preferably be fitted in the same rack and positioned immediately adjacent to each other.

Due to the weight of the assembly it is usual to mount the UPS cabinet and optional battery cabinet (where used) near the bottom of the rack.

There is no minimum space requirement above or below the UPS cabinet when it is in-situ, but a minimum of 200mm should be provided at the rear of the unit to allow for adequate cooling air flow and facilitate cabling. As the UPS cabinet is 600mm deep this implies a minimum rack depth of 800mm.

As mentioned above, rear access is required for cabling therefore sufficient room should be provided behind the rack to permit easy passage – recommended 900mm. A similar space is required at the front of the rack to enable the UPS cabinet to be handled while it is being installed.



CAUTION: The UPS cabinet is heavy. Ensure that sufficient personnel and appropriate handling equipment are available to install the unit safely.

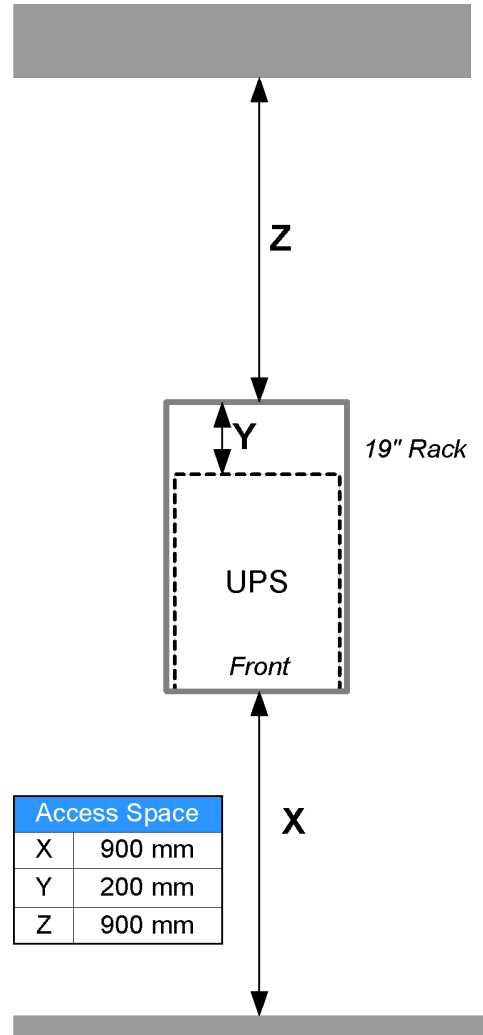

Figure 3.2 Rack-mounted clearances

3.2.3 Environmental considerations

The following conditions apply to both Tower and Rack-mounted installations.

- The UPS location should be subject to a humidity of less than 90% (non-condensing) and temperature between +15°C to +25°C.
- A temperature of 20°C is recommended for optimum battery life.
- The location should be free from dust or corrosive/explosive gases.
- The location should not be subject to vibration.
- The air conditioning system must be able to provide a sufficient amount of cooling air to keep the room at, or below, the maximum permissible operating temperature.

3.3 UPS Installation Procedure

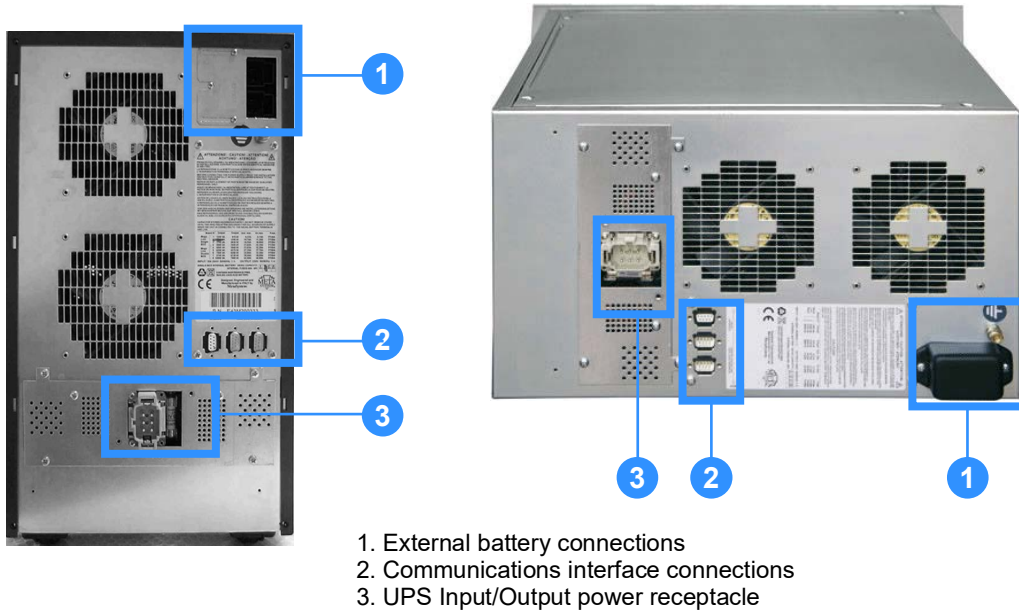

Note that the Rack-mounted rear panel is identical to the Tower version but turned on its side.

Figure 3.3 MINIpowerPLUS 5000 Electrical connections

The UPS is installed in three stages:

1. Connect the UPS cabinet to the battery cabinet – not applicable in a standard MINIpowerPLUS 5000 installation unless an external battery option is used (see paragraph 3.3.1).
2. Connect the UPS communication options (see paragraph 3.3.2).
3. Connect the UPS input/output power cables (see paragraph 3.3.3).
4. Power ON the UPS if commissioning is not required (see paragraph 3.3.4)



WARNING: Ensure the UPS is isolated from the mains supply while making electrical connections.

3.3.1 Connect the UPS cabinet to the battery cabinet

In a MINIpowerPLUS 10000 system the UPS batteries are housed in a separate battery cabinet that is connected to the UPS cabinet by three cables. In a MINIpowerPLUS 5000 system a separate battery cabinet is an optional facility that is sometimes added to provide an extended autonomy time over and above that available from the standard internal batteries.

All interconnecting cables are provided in the accessories pack that is shipped with the battery cabinet.

MINIpowerPLUS 10000 installation

Note: Applies to models 5000/2, 6250/2, 7500/2, 8750/2 & 10000/2.

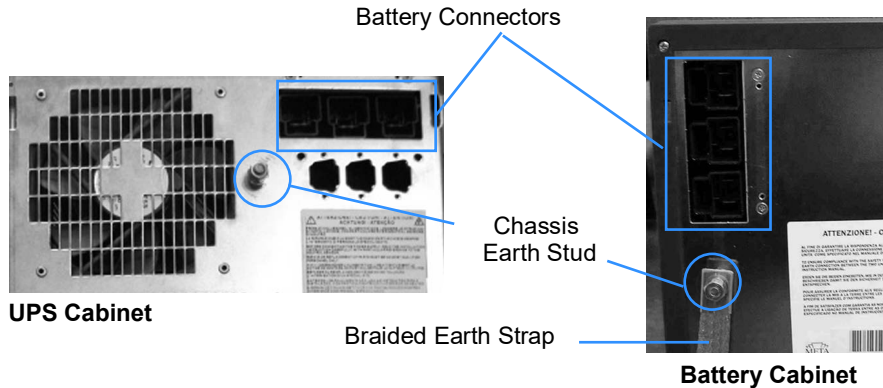

Figure 3.4 MINIpowerPLUS 10000 battery connections

1. Connect the flexible braided earth strap (provided) between the chassis earth studs of both cabinets – the studs are located adjacent to the battery connectors.
2. Connect all three battery cables between the battery connectors on both cabinets. The cable plugs are keyed to prevent incorrect polarity when making these connections.

Note: It does not matter which sockets are connected to which cable, provided all three cables are connected.

MINIpowerPLUS 5000 installation (Tower and Rack-mounted)

Note: Applies to models 1250, 2500, 3750 & 5000.

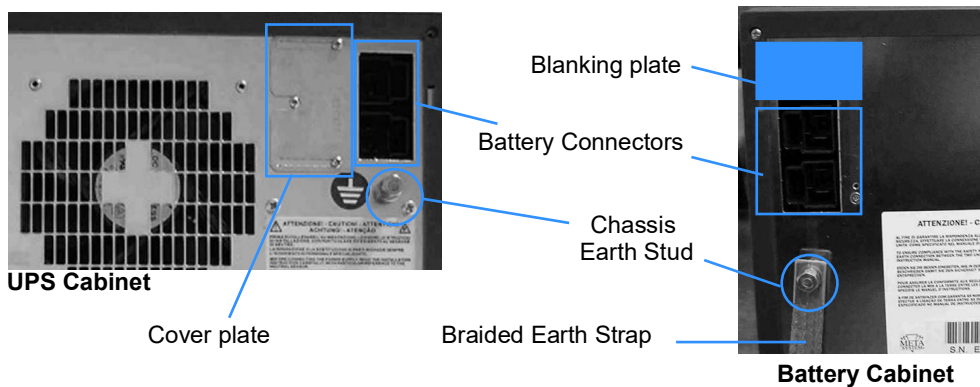

Figure 3.5 MINIpowerPLUS 5000 battery connections

1. On the back of the UPS cabinet, loosen the two screws securing the battery connector cover plate. Slide the cover plate open to expose the battery connectors then re-tighten the securing screws to hold the cover plate open.
2. Connect the flexible braided earth strap (provided) between the chassis earth studs on both cabinets – the studs are located adjacent to the battery connectors.
3. Connect two of the three provided battery cables between the battery connectors on both cabinets. The cable plugs are keyed to prevent incorrect polarity when making these connections.

Note: On the battery cabinet the top connector will be covered by a blanking plate. It does not matter which of the remaining two sockets are connected to which cable, provided both are connected.

Extended battery cabinet connections

Additional battery cabinets can be connected to either of the above systems to further extend the available autonomy time.

Where an extended cabinet is used, the standard cabinet inter-connect cables are replaced by ‘splitter’ cables that can be effectively daisy chained to connect any number of cabinets together – as illustrated in Figure 3.6.

When several cabinets are connected as shown, the battery charger within the UPS cabinet may not be able to adequately charge all the additional batteries. In this case an independent battery charger is fitted to each extended battery cabinet which must be connected to a mains supply using a standard IEC power cord.

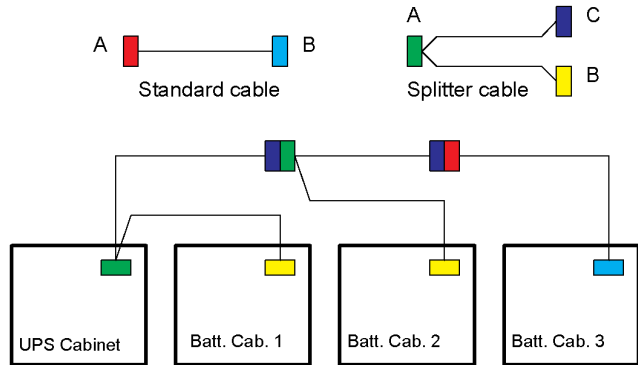

Figure 3.6 Extended battery cabinet connections

3.3.2 Connecting the UPS communication options

On the UPS cabinet back panel there are three D-type connectors that provide various optional communication facilities.

The 9-pin female connector provides an RS232 communications port that can interface with a range of monitoring and control software – such as the CS121L Adapter Box for monitoring software using SNMP and MODBUS.

The remaining connectors (9-pin male) provide logic output signals that can be used to drive remote alarms and indication facilities – this is normally carried out via a relay interface board (see paragraph 7.3.1).

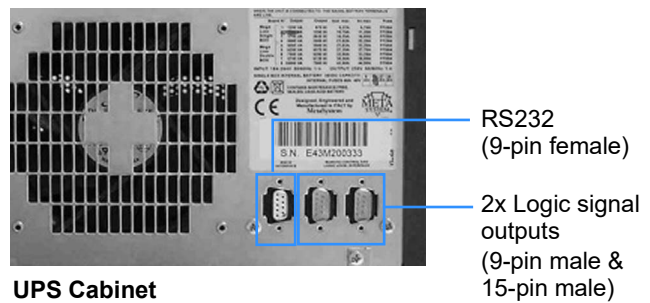

Figure 3.7 Communication connections

The following output signals are provided:

9-pin	15-pin	
1	5	Input ON/OFF (Max. voltage +15V, equivalent to the ON/OFF button on the front control panel)
2	4	+15V (max 30mA)
3	3	AUTONOMY RESERVE (active high 15V, max 5mA)
4	2	UPS RUN ON BATTERY (active high 15V, max 5mA)
5	1	GND (common)
6	15	GENERAL ALARM (Open collector active low, max 50mA)
7	14	AUTONOMY RESERVE (Open collector active-low, max 50mA)
8		GND (common)
9	12	UPS RUN ON BATTERY (Open collector active-low, max 50mA)
	7	OVERLOAD (Open collector active-low, max 50mA)

These outputs can be used individually or connected to an optional Remote Signalling Panel (RSP).

3.3.3 Connect the UPS input/output power cables

The UPS input and output cables are fitted to a single power connector that plugs into a receptacle located on the rear UPS cabinet wall. A ready-made connector complete with cable is provided with the equipment. The supplied cable is approximately 600mm in length and terminated with an input plug and outlet socket suitable for the UPS capacity rating. Where the supplied cable length is inadequate for a particular installation it can be replaced by a longer cable following the instructions contained at the end of this section.

Note: If the UPS connector is fitted with a maintenance bypass switch refer to the Options chapter in this manual for details (see paragraph Figure 7.1).



Key Point: A link is fitted in the power connector which ensures that the UPS cannot be started unless the connector is plugged-in to the UPS power receptacle.



CAUTION: Before proceeding, either ensure that the UPS input power cable is disconnected from the mains supply or, if the cable is connected directly to the mains, ensure that the mains supply is isolated at the distribution point.

MINIpowerPLUS 5000 power cables

A cable with a maximum capacity of 16A is supplied with the MINIpowerPLUS 5000. For applications where the anticipated UPS input current exceeds 13A (e.g. 5000 VA with $V_{in}=184V$) we recommend that the UPS input power cable is connected directly to the electrical distribution control panel. If this requires a longer power cable the connector can be rewired as shown below in Figure 3.9.

MINIpowerPLUS 10000 power cables

A ready-made cable of approximately 600mm in length, fitted with standard IEC connectors, is supplied with the UPS. If it is necessary to rewire the connector the cable must be a minimum of 4mm² and have insulated wires – see Figure 3.10.

MINIpowerPLUS 5000

1250, 2500, 3750 & 5000

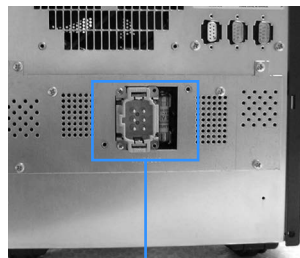

Power Receptacle
& Input Fuse

MINIpowerPLUS 10000

5000/2, 6250/2, 7500/2, 8750/2 & 10000/2

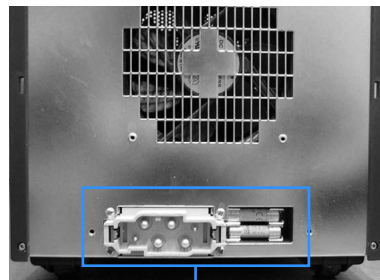

Power Receptacle
& Input Fuse

Figure 3.8 UPS input/output power receptacles

Connecting the UPS power connector

1. Connect the UPS input/output power connector assembly to the power receptacle on the rear of the UPS and secure in place using two screws, as shown in Figure 3.8.
2. Check that all the UPS loads are turned OFF then connect the UPS output cable to the load distribution point.
3. Connect the UPS input mains supply cable to a power outlet adequate for the voltage and current required.

MINIpowerPLUS 5000 power connector wiring



CAUTION: Ensure the UPS input mains supply is isolated before proceeding.

Never remove the 230V power plug whilst the UPS is in operation as this would disconnect the earth protection of both the UPS and of the connected loads.

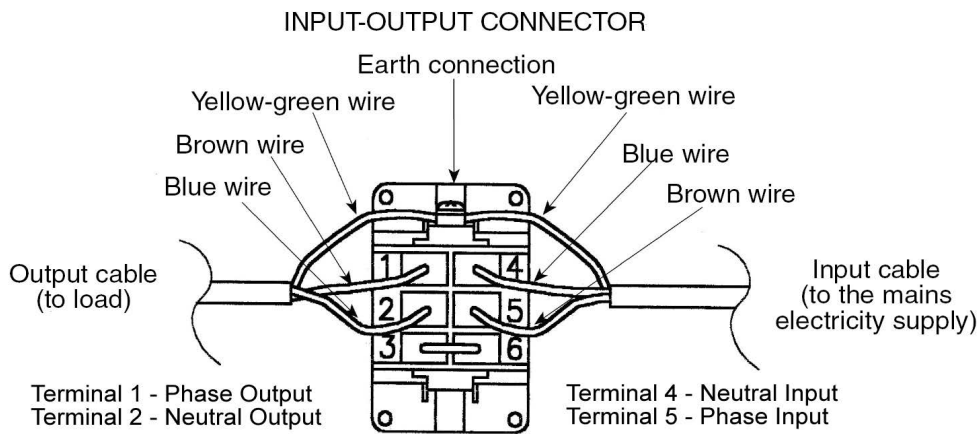
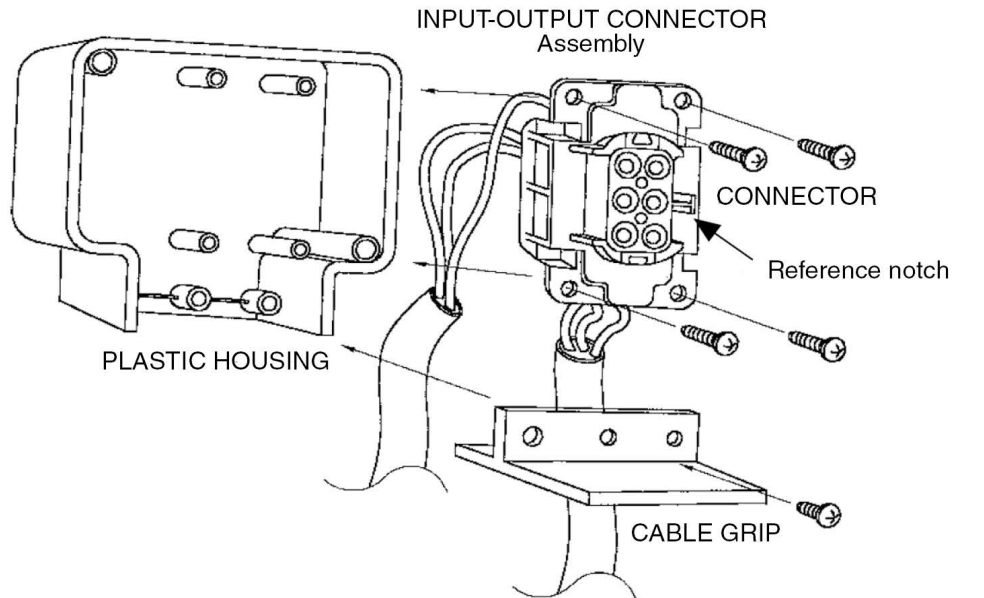

Figure 3.9 Input/Output power connector wiring

MINIpowerPLUS 10000 power connector wiring



CAUTION: Ensure the UPS input mains supply is isolated before proceeding.

Never remove the 230V power plug whilst the UPS is in operation as this would disconnect the earth protection of both the UPS and of the connected loads.

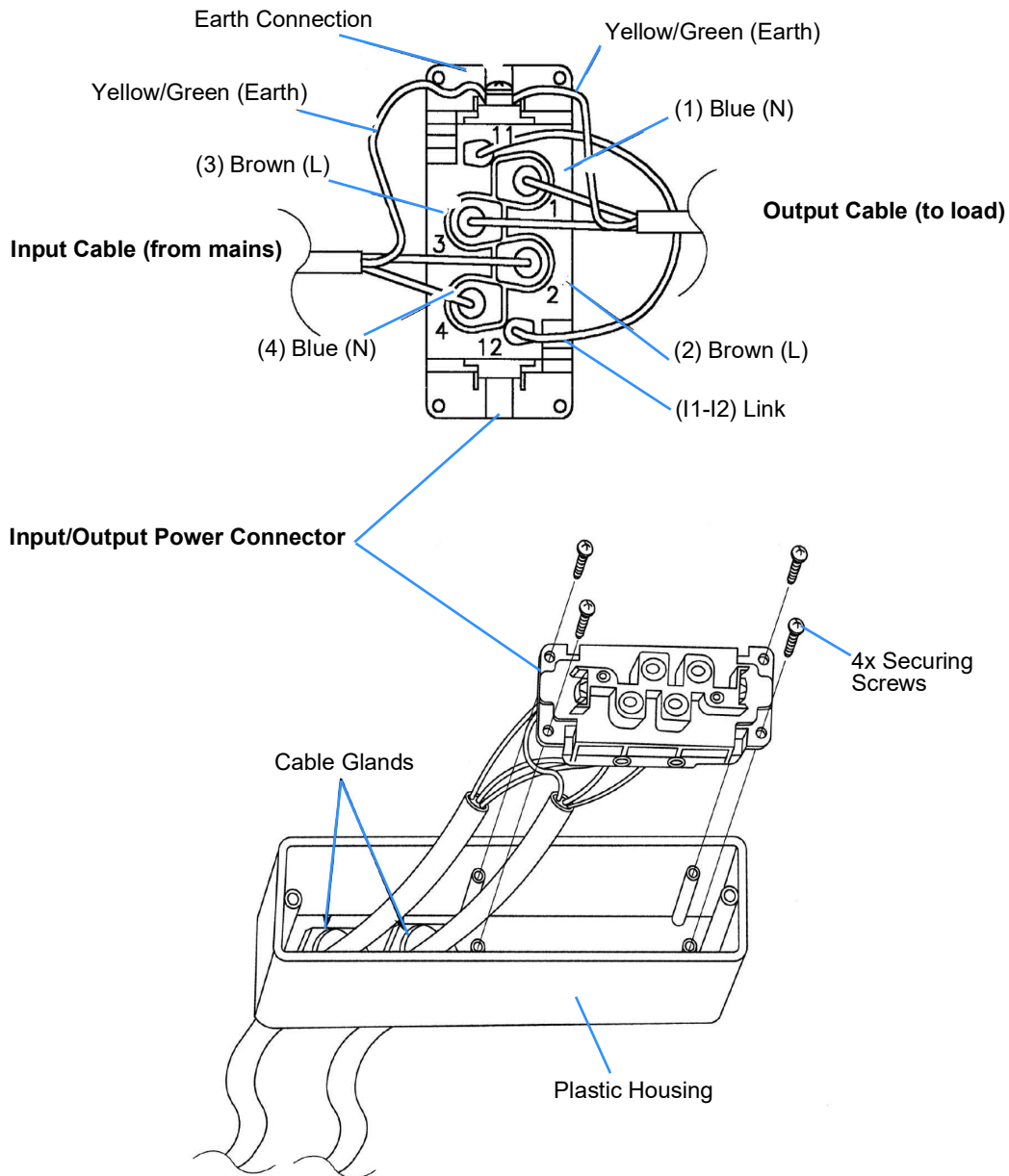

Figure 3.10 Input/Output power connector wiring

3.3.4 Powering ON the UPS



WARNING: If the batteries are not already fitted and connected:

- Do not continue beyond this point in the installation procedure. The equipment must be commissioned by a manufacturer-approved engineer.
- Do not turn on the input mains power until the equipment has been commissioned.

If the UPS batteries are already fitted and connected you can apply power to the UPS at this stage and, provided the power-on indications described below are satisfactory, you can put the UPS into operation.

1. Ensure the load equipment is turned OFF or otherwise isolated from the UPS output supply.
2. Turn ON the UPS input mains supply.
3. The UPS is fitted with protection against incorrect power connections. If the red warning light on the UPS control panel is permanently illuminated (not flashing) and the internal warning buzzer is continuously sounding you should immediately turn off the input mains power supply, disconnect the UPS power connector and seek the manufacturer's advice.

If the initial power-on indications (above) do not indicate a fault, you can connect the load equipment to the UPS output and switch ON the UPS following the Operating Instructions contained in Chapter 4 of this manual.

Important final checks

As current dispersion towards earth of all the loads merges in the UPS protection wire (earth wire), for safety reasons, it is essential to check that the sum of these currents does not exceed 2.7 mA, according to BS EN 62040-1-1:2003.

4 Operation

4.1 Operating Instructions

Two sets of Operating Instructions are provided below; the first applies to a standard installation and the second applies if the Maintenance Bypass option is fitted.

Note: If the Maintenance Bypass option is fitted there will be a BYPASS switch on the mains power connector plugged into the back of the UPS.



WARNING: If the UPS was supplied without the batteries already fitted and connected, the system must be commissioned by a manufacturer-approved service engineer before it is powered up for the first time.

Once the UPS has been commissioned it is very straightforward to operate.



Key Point: Before operating the UPS for the first time, you should familiarise yourself with the Control Panel functions described in paragraph 4.2.

4.1.1 Standard installation without the maintenance bypass option fitted

To switch ON the UPS

1. Ensure that it is safe to apply power to the load equipment.
2. Switch ON the UPS input mains supply.
3. On the UPS Control Panel press the ON/OFF button once.
 - a) The Control Panel LCD display will initially show UPS Switching on...
 - b) As the UPS runs through its start-up checks the Control Panel status indicator will change from red to yellow and then finally remain green.
 - c) The UPS Control Panel LCD display will show the UPS input and output parameters and appear similar to the example shown in Figure 4.2.
4. The UPS is now fully operational and providing your load equipment with a protected, backed-up supply.
5. You can now further monitor the UPS operating parameters using the Status Menu, as described in paragraph 4.4.2.

To switch OFF the UPS

1. On the UPS Control Panel press and hold the ON/OFF button for a few seconds.
The UPS audible alarm will sound repeatedly and the UPS will switch OFF after 5 seconds.
2. To completely isolate the UPS disconnect the UPS input mains supply.

4.1.2 Installation with Maintenance Bypass option fitted

To switch ON the UPS (assuming the maintenance bypass switch is closed)

1. On the UPS Control Panel press the ON/OFF button once.
 - a) The Control Panel LCD display will initially show UPS Switching on...
 - b) As the UPS runs through its start-up checks the Control Panel status indicator will change from red to yellow and then finally remain green.
 - c) The UPS Control Panel LCD display will indicate the UPS input and output parameters and appear similar to the example shown in Figure 4.2 except that there will be no output power shown as the load is currently being powered via the maintenance bypass switch.

2. Transfer the UPS output to its internal static bypass as follows (Note: the UPS SETUP menu may be password protected):
 - a) Access the MAIN MENU>UPS SETUP>BYPASS menu, as shown on page 20.
 - b) From the BYPASS menu, select and **enable** Forced Mode. This will turn on the UPS static bypass which is now effectively connected in parallel with the Maintenance Bypass supply.
3. OPEN the maintenance bypass switch (0) on the UPS mains power connector.
 - a) The light in the switch will extinguish.
 - b) The load will transfer to the UPS static bypass line.
4. Transfer the UPS output to the Inverter as follows:
 - a) Access the MAIN MENU>UPS SETUP>BYPASS menu, as shown on page 20.
 - b) From the BYPASS menu, select and **disable** Forced Mode.
5. The UPS is now fully operational and providing your load equipment with a protected, backed-up supply.
6. You can now further monitor the UPS operating parameters using the STATUS Menu, as described in paragraph 4.4.2.

To transfer the load from the UPS to the maintenance bypass line

1. Transfer the UPS output to its internal static bypass as follows (Note: the UPS SETUP menu may be password protected):
 - a) Access the MAIN MENU>UPS SETUP>BYPASS menu, as shown on page 20.
 - b) From the BYPASS menu, select and **enable** Forced Mode. This will operate the UPS static bypass.
2. CLOSE the maintenance bypass switch (1) on the UPS mains power connector.
 - a) The light in the switch will illuminate.
 - b) The load will transfer to the UPS maintenance bypass line.
3. To completely shutdown the UPS, press the ON/OFF button for a few seconds. The UPS audible alarm will sound repeatedly and the UPS will switch OFF after 5 seconds.
4. Once the UPS is shut down the mains power connector can be disconnected from the UPS power receptacle, leaving the UPS free to be removed if required whilst maintaining the load power through the maintenance bypass switch.



CAUTION: When the load is connected via the maintenance bypass supply it is not protected against mains failure or other power aberrations.

To power down the load when on the maintenance bypass line

1. If the load is supplied through the maintenance bypass line it can be powered off and on by means of the maintenance bypass switch.

4.2 Control Panel

The UPS is fully controlled from the operator control panel located on the front of the UPS.

The user-friendly control panel comprises three areas:

Alpha-numeric LCD Display

Normally provides indication of the UPS operating mode together with the input/output supply parameters and the battery 'state of charge' (SOC). It also displays error messages and UPS set-up data via the control menu system

Operator Keypad

Provides keys to navigate through the UPS control menu system together with an ON/OFF button.

Operating status indicator

The area behind the mimic diagram is illuminated by a multi-coloured led to indicate the UPS operating status.

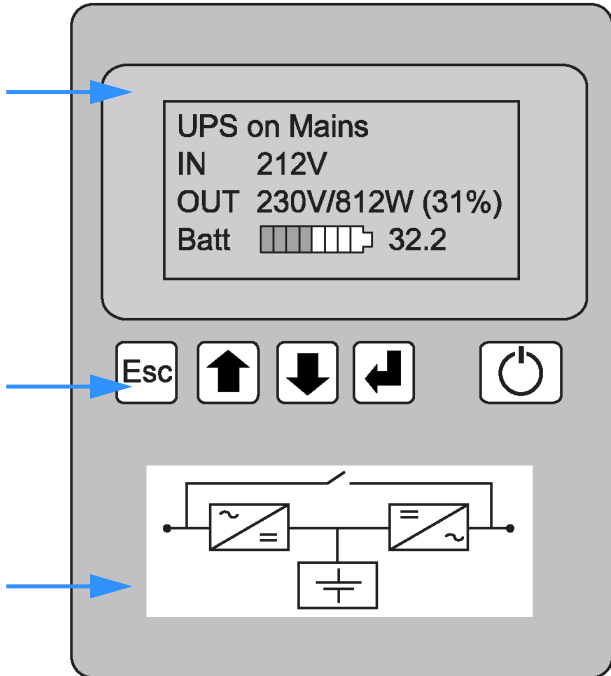

Figure 4.1 Operator control panel

4.2.1 Alpha-numeric LCD Display

UPS	On Mains	Normal operating status when the input mains voltage is present.
	On Battery	There is no mains power and the UPS is running on its batteries.
	On By-pass	The UPS internal bypass circuit has been turned on and the UPS output is connected directly to the UPS input mains supply
IN	xxxV	Indicates the UPS input voltage and the RMS power absorbed from the mains. This indication is not displayed during battery operation.
OUT	xxxV/ x,xKW (xx%)	Indicates the output voltage and power. The power is shown in kW and also as the percentage of the total power that the UPS is able to supply.
Batt.	xx,x	Indicates the battery state of charge in a bar graph format together with a numerical indication of the available autonomy time (in minutes)

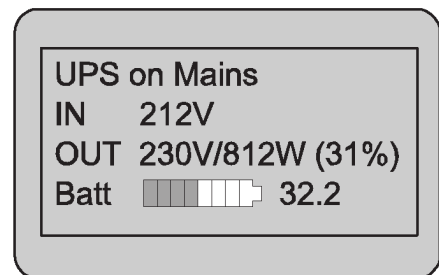
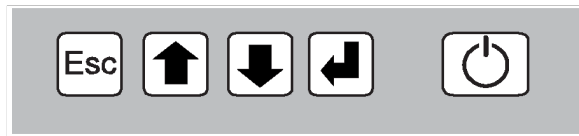

Figure 4.2 LCD Display panel during normal operation

4.2.2 Operator Keypad



	<p>ESCape Key</p> <ul style="list-style-type: none"> • Exit a function without modifying it • Go up one menu level • Exit the main menu and return to the status display • Silence the buzzer
	<p>SCROLL UP Key</p> <ul style="list-style-type: none"> • Select previous function • Increase a value • Select a new item within the function (e.g. go from DISABLED to ENABLED)
	<p>SCROLL DOWN Key</p> <ul style="list-style-type: none"> • Select next function • Reduce a value • Select a new item within the function (e.g. go from ENABLED to DISABLED)
	<p>ENTER (SELECT) Key</p> <ul style="list-style-type: none"> • Confirm a value • Access an item in the menu • Go down a menu level
	<p>ON/OFF</p> <ul style="list-style-type: none"> • UPS ON/OFF pushbutton

Figure 4.3 Operator keypad functions

4.3 Alarms and Indications

Note: Press the ESC key to silence the audible warning.

Status Indicator	Audible Alarm	Message	Description
Solid Green	None	UPS on Mains IN xxxV	Normal operation. Mains OK and load within limits.
Fast flashing Green	None	UPS on Mains No sync mains xx.xHz	Output and input voltages are unsynchronised. Possible causes: <ul style="list-style-type: none"> • PLL disabled • Input frequency outside limits
Solid Yellow	Short intermittent every 20sec	UPS on Batteries MAINS ABSENT	UPS input supply has failed (or out of spec) and the UPS is operating from its battery supply (batteries are discharging)
Fast flashing Yellow	None	UPS on Bypass	Load is connected directly to the mains supply via the bypass.
Fast flashing Red	Short, fast intermittent		Module failure: Switch off the UPS and contact your service centre Overload: Reduce the load until it is within the UPS capacity.
Solid Red	Continuous		UPS error or failure. Please contact your service centre
Flashing Red (10s)			Above 90% of MAX load
Flashing Red Alternating short/long	Alternating short, long intermittent	RESERVE AUTONOMY!	Autonomy reserve. During battery operation <ul style="list-style-type: none"> • Incorrect battery connection • Incorrect Neutral
Flashing Red Short with pause		OUT OF REDUNDANCY!	The load consumption exceeds the set redundancy. Power module redundancy is not guaranteed in case of failure.

4.4 UPS Customisation and Event Monitoring Menus

The UPS control system can be monitored and customised through a series of menus that can be displayed on the LCD panel and accessed using the operator keypad buttons. This facility is used by the service engineer to set-up the UPS during commissioning and to monitor the UPS performance and alarms history when undertaking maintenance or troubleshooting.



WARNING: Some of the configuration functions accessible via the customisation menu can adversely affect the UPS operating performance if programmed incorrectly. These adjustments and configuration settings must be carried out by a trained engineer.

Accessing the Menus

The menu system can be accessed by pressing the ENTER key, which will initially display the Main Menu. From the Main Menu you can navigate to any of the lower-level menus shown below by using the SCROLL UP / SCROLL DOWN keys to highlight the required menu option and then press the ENTER key to select it. Note that the menus can be accessed even if the UPS is switched off.

To exit the menus and return to the normal display screen you must press the ON/OFF key.

4.4.1 Main Menu

The Main Menu provides access to five menus at the next level as shown in Figure 4.4.

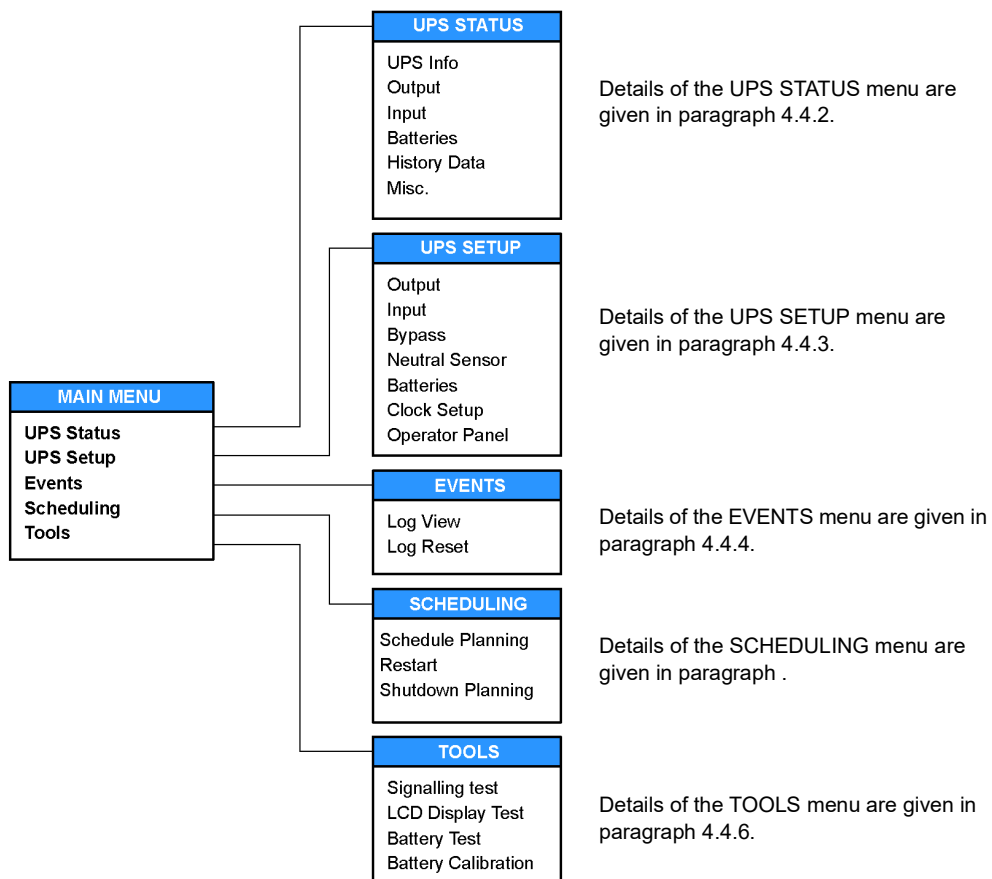
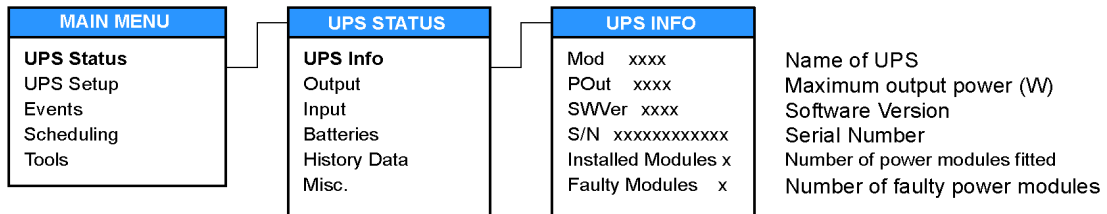

Figure 4.4 Main Menu

4.4.2 UPS Status Menus

The UPS Status menus provide the user with information concerning the UPS set-up configuration and operational data – both live and historical. Most of the sub-menus are self-explanatory, as shown below.

UPS Info sub-menu



Output sub-menu

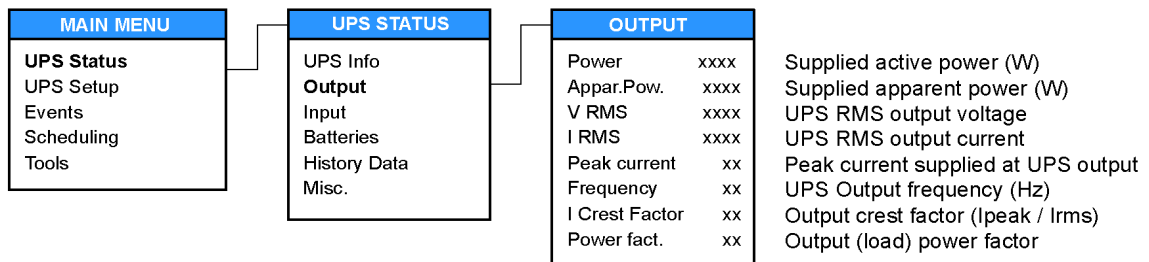

Input sub-menu

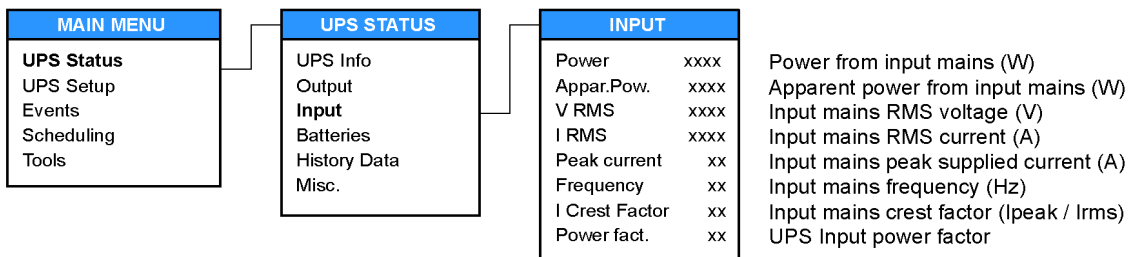

Batteries sub-menu

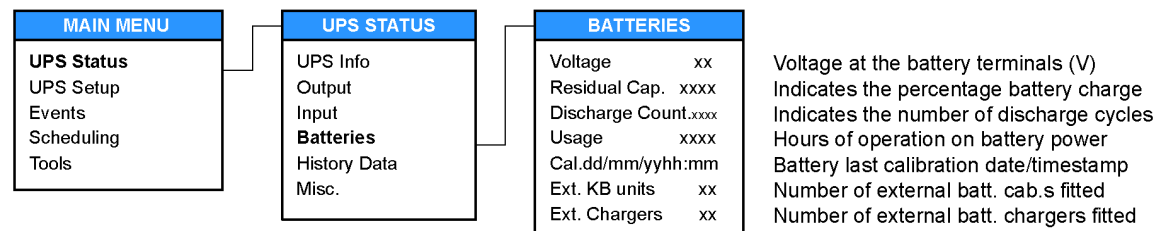

History Data sub-menu

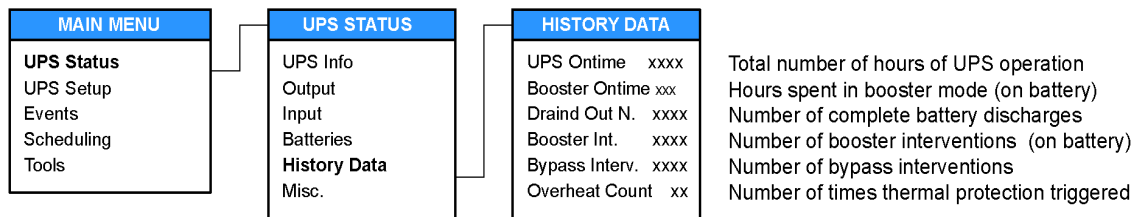

Misc. sub-menu

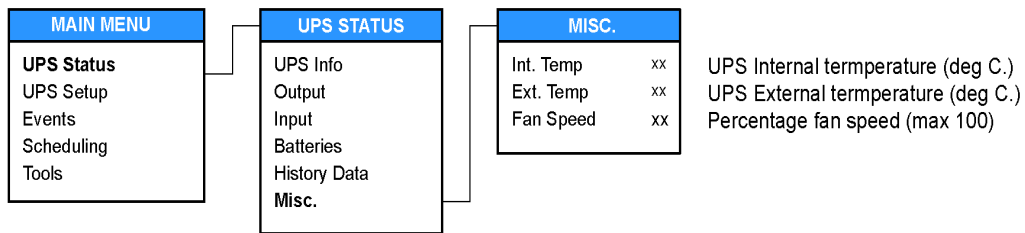

4.4.3 UPS Setup Menu

The UPS Setup menu is used to set-up various UPS operating parameters and functions. This menu can be password protected to prevent unauthorised access – (see "Operator Panel sub-menu," on page 22).

Output sub-menu

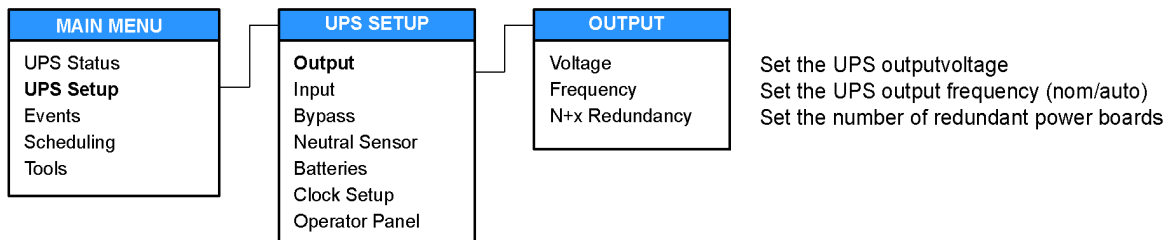

Frequency: This can be set to a nominal value (i.e. 50Hz or 60Hz) or it can be configured as AUTO whereby the UPS output frequency synchronises to the input mains frequency and changes to the nominal value (50/60Hz) if the input mains supply fails.

N+x Redundancy: Where a system is designed to incorporate a number of redundant power modules, the UPS contains more power modules than is required to power the full connected load. Therefore the system could lose one (or more) power module before its ability to provide full load power is affected.

The N+x Redundancy setting determines the number of modules that can be inoperative before the system sounds the OUT OF REDUNDANCY alarm. A practical example is shown in the table below:

Load (kW)	Fitted Power Modules	Total Available Power	Redundant Modules	Redundant Alarm Level (W)	System Overload Level (W)
3700	3	3750	0	no	3750
3700	4	5000	1	3750	5000
1500	4	5000	2	2500	5000
1000	4	5000	3	1250	5000

Input sub-menu

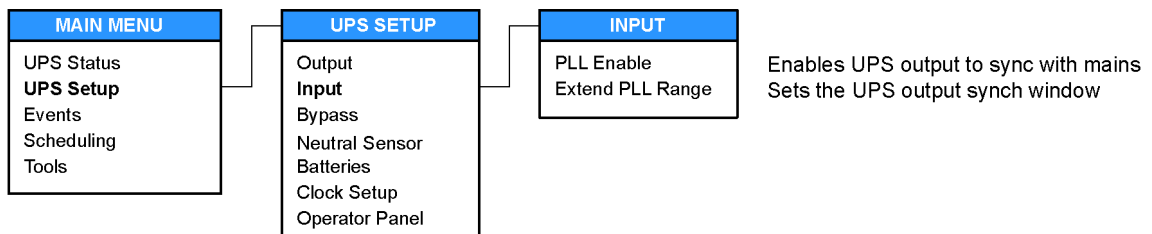

PLL Enable: If enabled, the UPS synchronises the output frequency to the input frequency. If disabled, the UPS output frequency is not synchronised, the Green status led flashes and the 'automatic bypass' facility is inhibited which means that the load is not fully protected in the event of a UPS fault or overload condition.

Extended PLL Range: When enabled, the UPS output frequency synchronisation range is $\pm 14\%$ of the nominal input frequency. When disabled this is reduced to $\pm 2\%$.

Bypass sub-menu

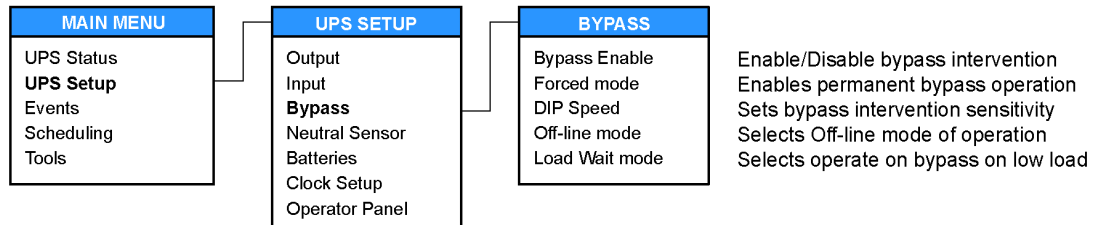

Bypass Enable: If enabled, the UPS manages bypass operation automatically. If disabled, the UPS will never switch to bypass and will switch off in the event of sustained overload or fault.

Forced Mode: If enabled, the UPS is set to operate permanently on bypass. This is the method used to connect the load to bypass when operating in the 'ECO' mode.

DIP Speed: When 'Forced Mode' is disabled, this setting alters the speed of bypass intervention.

- SLOW: for loads which may cause high peak demands and are insensitive to input voltage disturbance.
- STANDARD: normal condition.
- FAST: For loads which are extremely sensitive to input voltage disturbance.

Off-line Mode: If enabled, the UPS operates in permanent bypass mode while mains supply is available and reverts to battery power if the mains supply fails.

Load Wait Mode: If enabled, the bypass operates normally for loads below the 'Minimum Load Threshold' but is not available for higher loads – i.e. for higher loads, during a mains failure the UPS switches OFF and is only restarts when mains is restored. The threshold value is entered in 'Watts'.

Programming priority:

Function	Enable Bypass	Forced Mode	Off-line Mode	Load Waiting
Forced	Enabled	Enabled	X	X
Off-Line	Enabled	Disabled	Enabled	Enabled
Off-Line	Enabled	Disabled	Enabled	Disabled
Load Waiting	Enabled	Disabled	Disabled	Enabled
Automatic	Enabled	Disabled	Disabled	Disabled
Bypass Disabled	Disabled	X	X	X

Neutral Sensor sub-menu

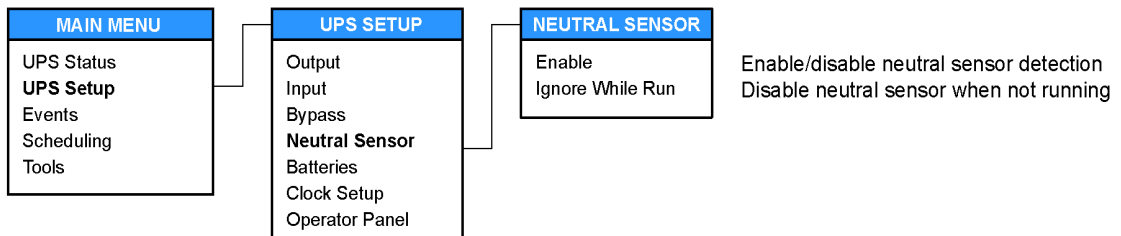

Enable: If enabled, the UPS uses the neutral sensor to verify that the voltage between neutral and earth is within safe limits and switches the UPS to battery mode when this is not the case.

Ignore While Run: If enabled, the UPS only checks the neutral sensor during startup.

Batteries sub-menu

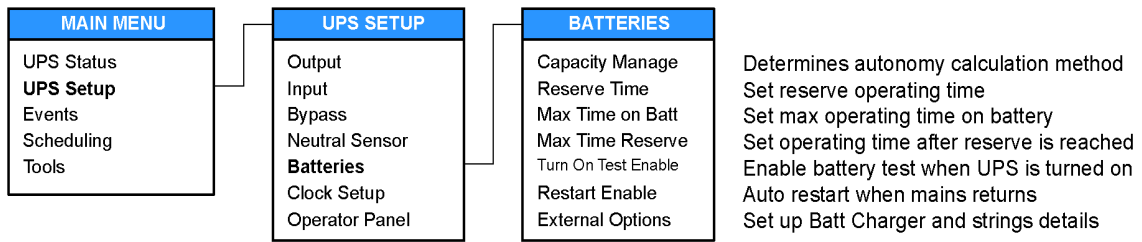

Capacity Manage: The Capacity Manage setting determines the method used to compute the remaining battery autonomy time that is available. This is used to activate the ‘Autonomy Reserve’ and ‘End Of Autonomy’ warnings shown on the LCD Display Panel when operating on battery power. When selected, the Capacity Manage menu presents further menu selections as shown and described below:

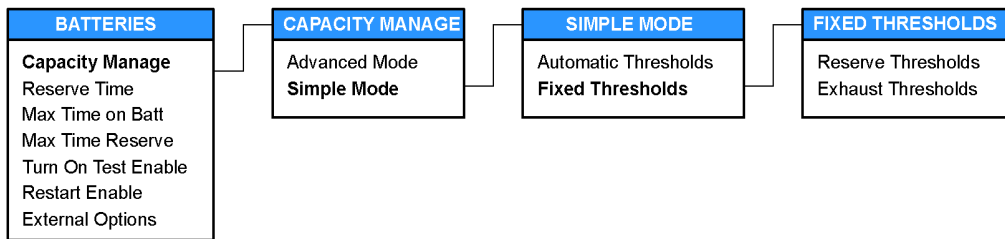

- Advanced Mode

In Advanced Mode the ‘Autonomy Reserve’ and ‘End Of Autonomy’ warning levels calculations are based on the power being drawn by the existing load.

- Simple Mode

In Simple Mode the end of autonomy warning calculation is based on the existing battery voltage.
Reserve Threshold: Sets the battery voltage at which the ‘Autonomy Reserve’ warning is displayed.
Exhaust Threshold: Sets the battery voltage at which the ‘End Of Autonomy’ warning is displayed.

Reserve Time: If enabled, sets the maximum time (in seconds) for operation in battery mode after the ‘Autonomy Reserve’ limit is reached. Set to ‘0’ to disable.

Max Time on Batt: If enabled, sets the maximum time (in seconds) for operation in battery mode. Set to ‘0’ to disable.

Max Reserve Time: If enabled, this will turn off the load when the remaining autonomy time falls to the set value. The time is set in minutes – set to ‘0’ to disable.

Turn On Test Enable: If enabled, it initiates a battery test every time the UPS is switched ON.

Restart Enable: If enabled, it forces the UPS to restart automatically when the mains supply is restored after the UPS has shut down due to the end of battery autonomy. If not enabled, the UPS will require starting manually

External Options: This provides access to two further menu options.

- Battery Chargers No.

Enter the number of battery chargers fitted to the external battery cabinets connected to the UPS system.

- KB Kits

Enter the number of battery strings connected to the system. Note that each string comprises three batteries.

Clock Setup sub-menu

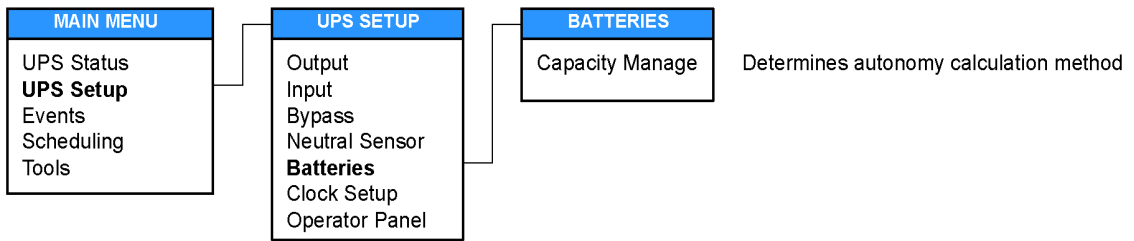

Operator Panel sub-menu

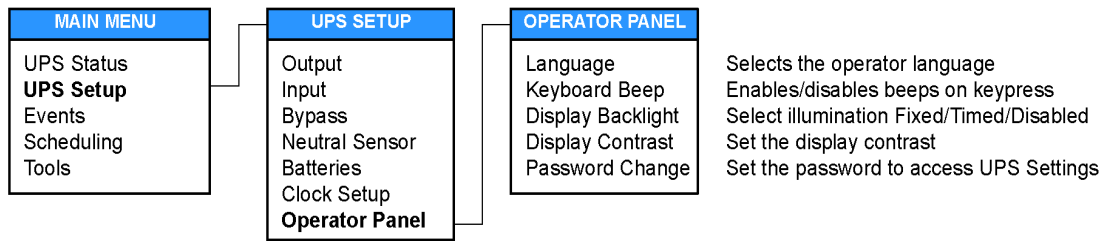

Display Backlight: This menu presents three options.

- OFF – Permanently OFF
- TIMED – Switches OFF after a period of inactivity
- ON – Permanently ON

Password Change: The password takes the form of an 8-digit number and is used to restrict access to the UPS Setup menu (paragraph 4.4.3). You will need to know the existing password in order to gain access to the password change menu. To change the password, allocate each new digit in turn using the UP/DOWN/ENTER keys. (Note that validation requires that all 8 digits are assigned a value.)

4.4.4 Events Menu

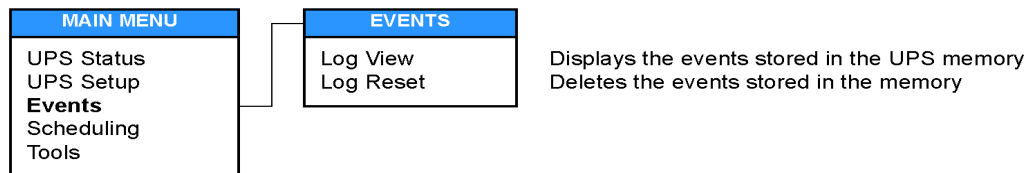

4.4.5 Scheduling Menu

Schedule Planning sub-menu

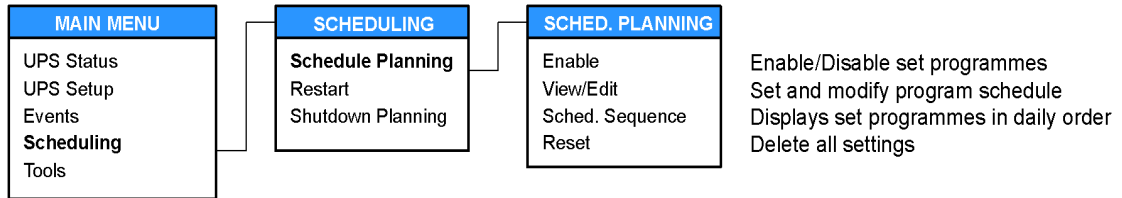

The Schedule Planning sub-menu allows various operating functions to be set to be programmed to operate at predetermined times.

Enable: This selection either enables or disables ALL the scheduled operations.

View/Edit: This allows details of the following programmed operations to be viewed or edited. Note that each one can be set to operate Daily (hh:mm), Singly (dd-mm hh:mm) or Weekly (name-of-day hh:mm).

- Battery Test – Verifies the battery status
- Batt. Calibration – Calibrates the batteries
- Turn ON – Switch ON the UPS
- Turn Off – Switch OFF the UPS
- Absent – Absent will be displayed if a selected View/Edit page is disabled

Sched Sequence: Displays up to 16 programmes in day/date order

Reset: Deletes all programmes.

Restart sub-menu

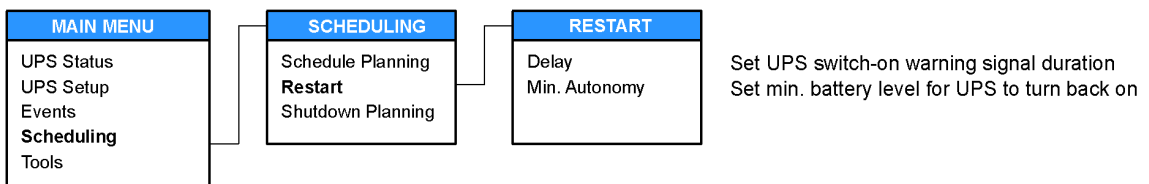

If the UPS is configured to automatically restart following the return of the mains supply, an audible warning is given to alert the operator that this is about to occur. The Restart sub-menu allows two parameters to be set which affect this operation.

Delay: This sets the time delay (in seconds) between the return of the mains supply and the automatic UPS start-up (i.e. the length of time that the restart warning alert signal is active).

Min Autonomy: This sets the percentage of battery discharge (autonomy) below which the UPS will not be permitted to automatically restart.

Shutdown Planning sub-menu

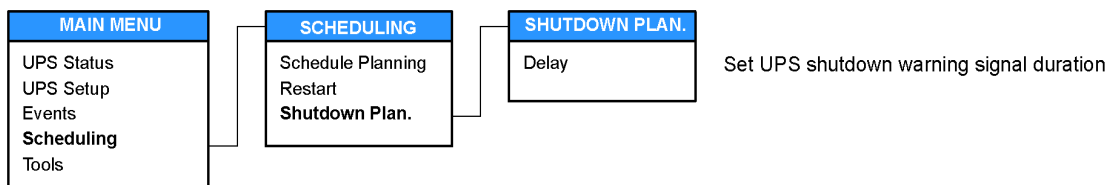

Delay: Sets the duration (seconds) of the signal warning that the UPS is about to be shut down.

4.4.6 Tools Menu

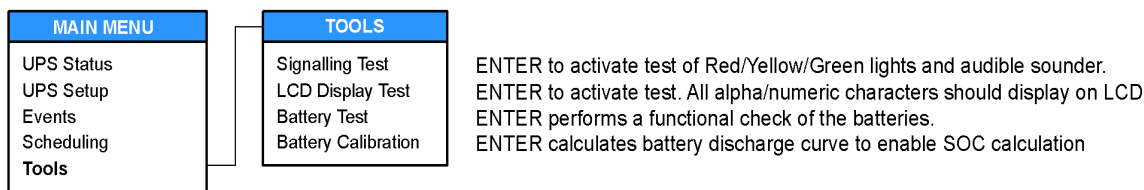

Signalling Test: This provides a facility to test the Green, Yellow and Red led warning indicators together with the audible warning device.

LCD Display Test: Tests the alpha-numeric LCD display. All LCD display characters should illuminate when the ENTER key is pressed.

Battery Test: Provides a battery test. Contact your service centre if the test fails.

Battery Calibration: Calibrates the batteries by calculating the discharge curve. This test should be carried out after the batteries have been charged so that the UPS is able to provide precise information on the charge status.

4.5 Diagnostic Software

The UPS is fitted with a standard RS232 interface that can be used to provide computer access to data relating to the operation of the UPS and its log. A suitable interface programme for Windows® computers, which requires an RS232 interface cable to connect the UPS to a serial port on your PC, is available from Kohler Uninterruptible Power For details, please contact the Technical Department at Kohler Uninterruptible Power

5 Maintenance

5.1 Introduction



WARNING: All the maintenance operations described in this chapter must be performed by an authorised electrician or other suitably qualified personnel.

As the UPS contains no user-serviceable parts, the maintenance requirements to be carried out by the user are minimal beyond ensuring that the UPS operating environment remains suitably cool and dust-free.

5.2 Routine maintenance

We recommend that the UPS operating parameters are checked and recalibrated annually as part of a regular maintenance schedule to ensure optimum UPS operation efficient load protection. The batteries should also be checked annually, depending on the ambient temperature.

When the UPS is commissioned, the commissioning engineer will attach a service record book to the front of the UPS which will be used to log the full service history of the UPS.



WARNING: Preventative maintenance inspections entail working inside the UPS with safety covers removed. This presents a risk of electric shock due to the unavoidable exposure to hazardous AC and DC voltages, and should be undertaken only by trained engineers authorised by Kohler Uninterruptible Power, who are fully aware of the hazardous areas.

During a preventative maintenance inspection the service engineer will check the following:

- Site environmental conditions
- Integrity of the electrical installation
- Availability and quality of the cooling airflow
- UPS Rectifier operation and calibration
- UPS Inverter operation and calibration
- UPS Static switch operation
- Battery condition and status
- Load characteristics
- Integrity of the alarm and monitoring systems
- Operation of all installed options

Preventative maintenance inspections form an integral part of all Extended Warranty Agreements (maintenance contracts) offered by Kohler Uninterruptible Power For further details on Extended Warranty Agreements see Section 2 of this manual.

5.3 Battery Testing

The battery test procedure can be activated from the UPS operator panel and can performed independently of the UPS operating mode (Off-line or On-line) and whether or not the load is connected.

6 Troubleshooting

6.1 Potential Problems and Solutions

Problem	Possible Solution
When the UPS is switched on, the buzzer sounds and the red warning light makes alternating short-long flashes, then the UPS switches off after 15 seconds	The connection of the neutral conductor is incorrect: <ul style="list-style-type: none"> • Swap the connections of the neutral and phase input leads, or exclude the neutral sensor
The UPS works but a short beep is heard every 12 seconds and the yellow warning light is lit without flashing.	Check power is present at the mains outlet. <ul style="list-style-type: none"> • Check that the UPS power supply cable is correctly inserted in both the mains outlet and in the connector on the UPS itself. • Check the fuse located at the side of the input/output connector under the plastic housing (see Figure 3.8).
The UPS works but it beeps intermittently and the red warning light and the yellow warning light are flashing.	There is an overload on the UPS output. <ul style="list-style-type: none"> • Reduce the load so that it does not exceed the maximum power that the UPS can supply. • Alternatively, if the UPS is not in its maximum configuration, you can ask your Service Centre to increase the power of your UPS by fitting extra power modules and batteries inside the UPS cabinet.
The UPS beeps continuously and the yellow warning light flashes for about 15 seconds, after which the UPS switches off.	The UPS has completely flattened its batteries; it can only start up again when the mains input line is present. <ul style="list-style-type: none"> • Check the magneto-thermal or differential switches that precede the UPS and the input fuse.
The UPS works but the green warning light is flashing quickly	The mains supply is out of the limits permitted for the voltage and/or frequency, but it can still be used by the UPS. However, the bypass function is not operational.
The UPS beeps intermittently and the red warning light is flashing quickly	The thermal protection has been tripped. <ul style="list-style-type: none"> • Switch the UPS off and wait for a few minutes so that the internal temperature of the UPS can get back to normal. • Check that the fans operate correctly and that the airflow is not obstructed (e.g. if the UPS is too close to a wall). • If the above steps are satisfactory, there is likely to be a fault on one of the internal circuits. Contact your service centre.

7 Options

7.1 Maintenance Bypass

7.1.1 Introduction

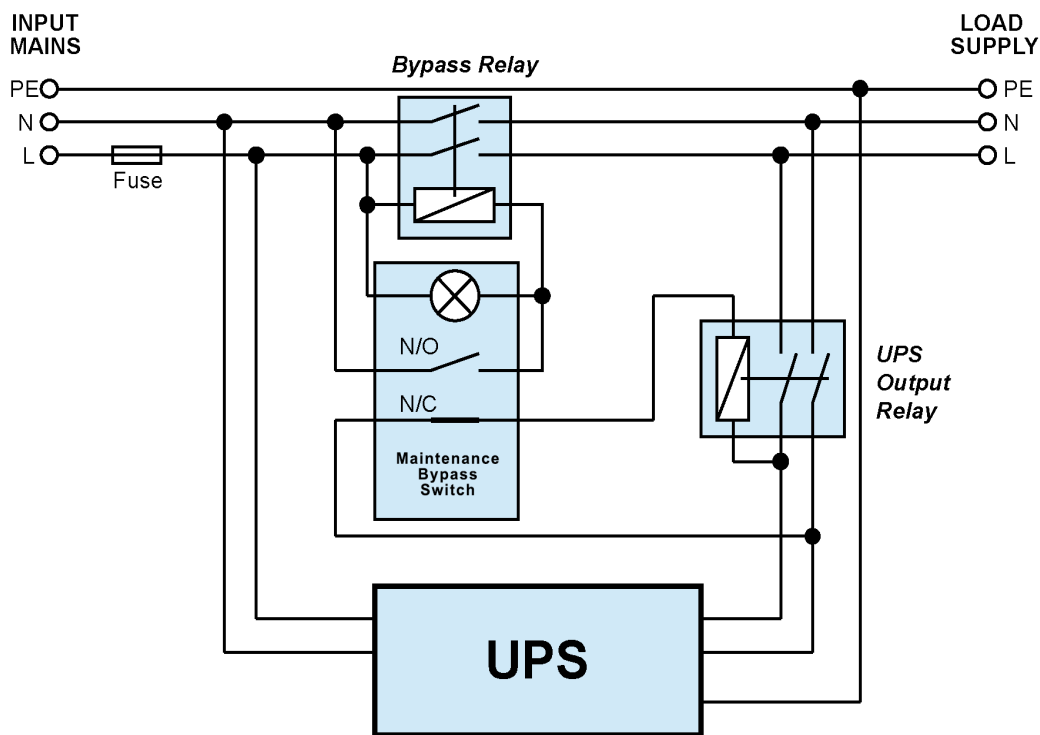

Figure 7.1 Maintenance bypass circuit

The Maintenance Bypass option allows the load to be transferred to the raw input mains supply if it is necessary to completely shut down or remove the UPS for maintenance or repair purposes.



Key Point: When the load is connected via the maintenance bypass supply it is not protected against mains failure or other power aberrations.

The maintenance bypass switch controls two relays, one of which is connected in the bypass circuit and the other in the UPS output line (see Figure 7.1). When the maintenance bypass switch is OPEN (0) the UPS output relay is closed, energised from the UPS output supply via a normally-closed switch contact, and the bypass relay is open. Conversely, when the maintenance bypass switch is CLOSED (1) the bypass relay is closed, and the UPS output relay is opened. This interlocking action prevents the UPS output from being back-fed from the raw mains supply.

Both relays and the maintenance bypass switch are built in to the UPS power connector (which replaces the standard power connector). The switch contains a yellow lamp which illuminates when the switch is closed to indicate that the load is connected to the maintenance bypass, as shown below in Figure 7.2.

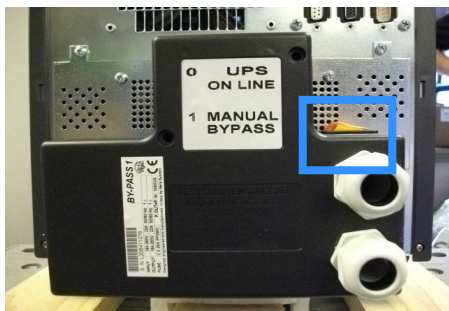

MINIpowerPLUS 5000

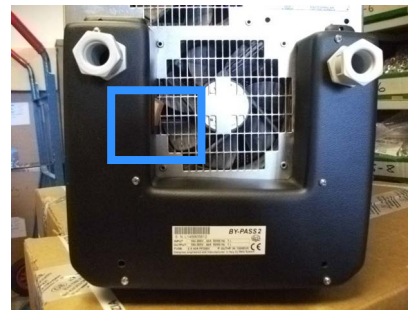

MINIpowerPLUS 10000

Figure 7.2 Maintenance bypass switch location

7.1.2 Installation

This procedure provided details of how to replace the standard UPS power connector with the optional maintenance bypass power connector.



WARNING: The maintenance bypass switch option must be installed by qualified personnel.



Key Point: Ensure it is safe to disconnect load power before proceeding. This procedure requires the UPS to be completely shut down and isolated from the mains supply.

1. Isolate the load and turn off the UPS.
2. Isolate/disconnect the UPS input mains supply cable and the UPS output supply cable to the load distribution point.
3. Disconnect and remove the power connector from the UPS power receptacle after first removing the two securing screws that hold it in place.
4. Dismantle the standard power connector and disconnect the input and output power cables – for details see Figure 3.9 and Figure 3.10.
5. Feed the input/output power cables removed from the standard connector (above) through the cable glands in the new connector's cover – observe the connection details in Figure 7.3 or Figure 7.4 to determine the correct orientation.
6. Connect the input and output cables to the replacement Maintenance Bypass Connector as shown in Figure 7.3 or Figure 7.4. – take care to ensure the cables are connected to the correct terminal blocks.
7. Tighten the cable gland ring nuts to hold the cables securely in place then attach and secure the connector's cover using the four M3 screws provided.
8. Connect the reassembled power connector to the UPS power receptacle and secure it in place using the two screws removed in step 3.
9. Install the two self threading screws provided with the bypass if the UPS chassis is complete with the corresponding holes.
10. Do not turn ON the UPS until the installation has been functionally tested, as described below.

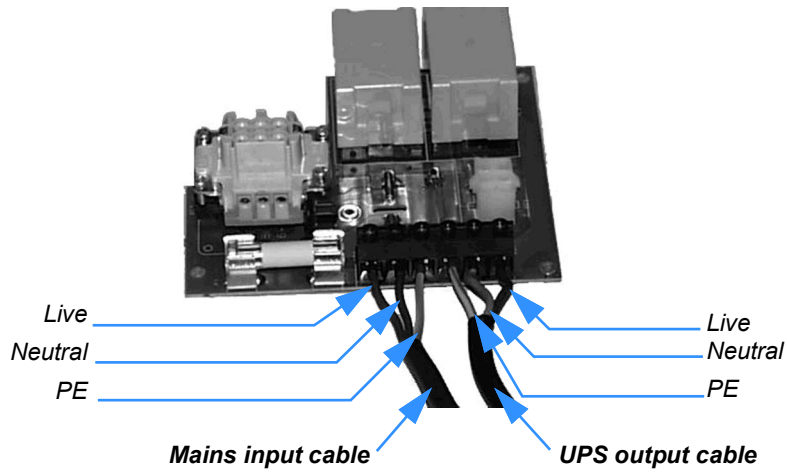

Figure 7.3 Maintenance bypass connector (MINIpowerPLUS 5000)

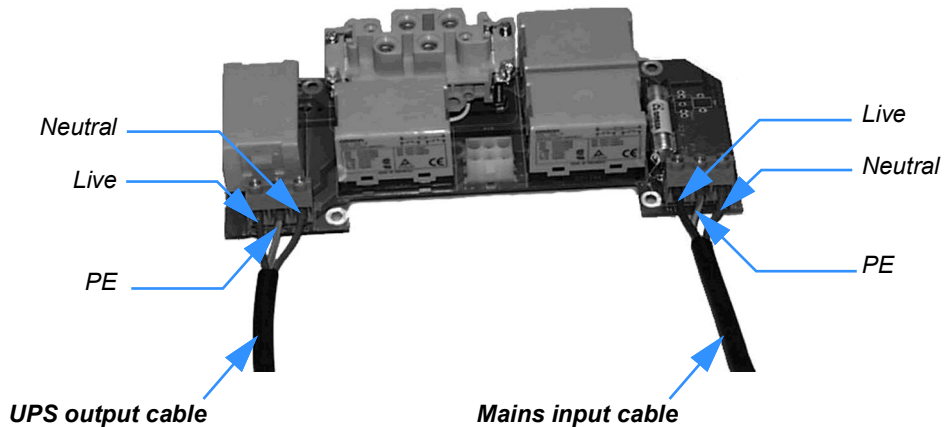

Figure 7.4 Maintenance bypass connector (MINIpowerPLUS 10000)

7.1.3 Functional testing

1. Connect the input cable to the mains power supply and connect a load to the UPS output (e.g. a lamp).
2. Turn ON the UPS input mains power.
3. With the UPS switched off, verify the following:
 - a) With the maintenance bypass switch in position I (MAINS), the yellow lamp illuminates in the switch and the load receives power.
 - b) With the maintenance bypass switch in position 0 (UPS), the yellow lamp in the switch extinguishes and the load receives no power.
4. Switch ON the UPS and check that the load receives power when the bypass switch is in both positions. If this does not occur:
 - a) Check the connection of the cables and the supply voltage rating.
 - b) Check that the UPS power connector is fully inserted into the UPS power receptacle.
5. If the above checks prove satisfactory:
 - a) Shutdown the UPS and turn OFF the input mains supply.
 - b) Disconnect the test load (lamp) and reconnect the normal load equipment.
6. Start the UPS following the procedure given in Chapter 4.

7.1.4 Maintenance bypass specification

	MINIpowerPLUS 5000	MINIpowerPLUS 10000
Input voltage	184V - 265V	184V - 265V
Output voltage	184V - 265V	184V - 265V
Input/Output Current	23A max	46A max
Maximum UPS power	5kVA	10kVA
Input line fuse	25A FF	2x32A FF
Protection	IP20	IP20
Dimensions (w x h x d)	240 x 145 x 59	224 x 250 x 55

7.2 Shutdown and Monitoring Software

7.2.1 Introduction

Power disruptions and depleted battery conditions pose the greatest threat to valuable computer data integrity. However, the risks inherent in these conditions can be alleviated by using a network management tool to monitor the UPS power supplies and alarm status.

By installing UPS/Mains monitoring software an administrator can monitor the utility power from a central location and obtain an early warning of impending power problems, even across more complex systems such as the Wide Area Networks (WAN) and Enterprise Wide Networks of multi-national companies.

To avoid a power loss due to depleted batteries, caused by a mains failure that exceeds the battery autonomy time, the UPS management software can initiate an automatic and controlled computer shutdown when the battery reaches a predetermined point in its discharge cycle. This allows valuable data to be saved and the operating system to be shut down gracefully before the power is lost.

Four monitoring systems are available for use with the MINIpowerPLUS UPS system:

- WAVEMON – can be used for monitoring and automatic shutdown
- SNMP – can be used for monitoring only
- PowerREPORTER – can be used to automatically email UPS monitored parameters and alarm events to Kohler Uninterruptible Power for appropriate response
- RELAY INTERFACE BOARD – provides volt free contacts for connecting to a remote alarm monitor

7.2.2 WAVEMON UPS monitoring software

WAVEMON is designed to operate with many of the Kohler Uninterruptible Power UPS systems and features both monitoring and automatic server/UPS shutdown facilities. The system comprises a bespoke software package which is installed on a local PC and communicates with the UPS over a standard RS232 cable connected to the RS232 port on the UPS back panel. The interconnecting RS232 cable can be up to 15m in length and may be connected/disconnected whilst the UPS is running.

The main characteristics of WAVEMON are:

- On-screen autonomy time/battery time countdown
- On-screen server log off and shutdown procedure
- Time and date stamp event log
- Extensive logging of all UPS activity and power quality data
- Allow alarm warnings to be monitored remotely via email
- Scheduled UPS service mode and other systems status
- Graphical user interface for Windows-compatible platforms
- Automatic unattended local shutdown
- Special modules for MS-Office software to close and save open documents
- Compatible with all optional modules like UPSDIALER, SNMP adaptors, temperature sensors, etc.

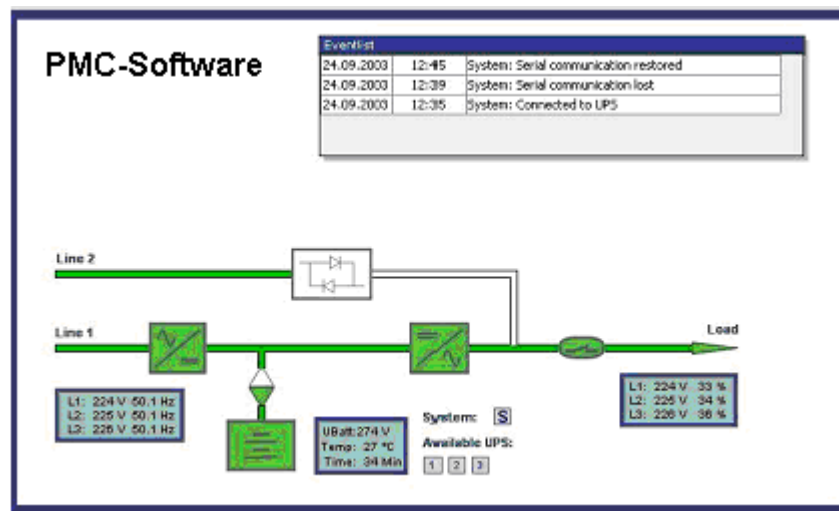

Figure 7.5 WAVEMON Monitoring screen image

WAVEMON Operation

The UPS-Management software is a client/server-application for networks and local workstations and consists of two parts: the server-module of the UPS-Management Software is called *UPSServ* and the client-module *UPSCli*.

The server-module (*UPSServ*) communicates with the UPS via the RS-232 cable and works as a background process which collects messages from the UPS, interprets them and then makes them available to the client-module (*UPSCli*) and to any operating SNMP-based management station.

When *UPSServ* detects a voltage variation or a power failure it can be programmed to execute various ‘system event’ routines, which for example may shutdown the server or send a warning message to connected users. These routines are a part of the UPS-Management Software and their functionality can be adjusted to suit the user’s demands.

RCCMD - Remote Console Command module for a multi-server shutdown

In some situations it is preferable to interface the MINIpowerPLUS to the network via an SNMP adapter, which allows up to 50 computers to be shut down in a RCCMD environment.

RCCMD (Remote Console Command) is an additional software module, which can be triggered by the SNMP device to execute a command (typically a shutdown command) on a remote system.

The MINIpowerPLUS can be integrated into a network by means of the server which is being powered by the UPS if it is already integrated into the network. In most cases the server is used as a sub-agent and you only need the PMC-Software without any SNMP Adapter. You need a standard serial connection between the RS232 port of the UPS and the RS232 port of the computer/server.

Licence conditions

The UPS management software includes the licence for using the UPS service on one server with one UPS and an unlimited number of connected Windows workstations. When operating with two or more servers, a further licence is required for each additional server, irrespective of whether the UPS service runs at that location or if the server is halted by a UPS service via remote command (*RCCMD*).

The same licence conditions apply to the use of remote send/receive modules (*RCCMD*) and multi-server shutdown under NT, UNIX and other operating systems. The service programs are generally delivered as a single-licence. To use a single CD ROM to shutdown multiple servers you must purchase additional CD license keys.

7.2.3 SNMP ADAPTER for network management/remote monitoring

Simple Network Management Protocol (SNMP) is a world-wide standardised communication protocol that can be used to monitor any network-connected device via a simple control language. The monitored results are displayed in a web browser.

When this facility is used in conjunction with the MINipowerPLUS, an external SNMP adapter is used which is connected to the RS232 connector on the UPS back panel. The SNMP adapter is then connected to the network by means of a standard RJ-45 terminated Ethernet connector.

The adapter is enclosed in a small box which must be powered from a backed-up supply supported by the UPS output so that its power is maintained in the event of a mains failure. A suitable plug-top power supply is included with the option kit.

Note: It is the customer's responsibility to provide a suitable, backed-up mains supply for the adapter.

The UPS-Management software agent installed in the SNMP adapter monitors the UPS operating parameters and outputs its data in SNMP format to the connected network.

In order to use this adapter the operating system you are using must be SNMP-compatible. We offer our software with SNMP functionality together with NetWare, OS/2, all Windows NT systems on INTEL and ALPHA. The SNMP adapter requires a PC with terminal connections, and for normal operation at least one Ethernet network connection is also required.

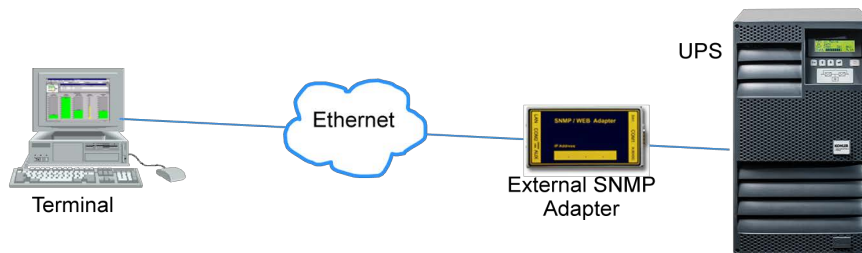

External SNMP Adapter

The small (125x70 mm) External SNMP adapter comes with following interfaces:

1. RJ-45 connector for 10/100 Base-T (auto switchable).
2. Serial Port for configuration (COM2) or optional ModBus interface.
3. Error/Link LED for UPS status.
4. Aux. Port.
5. DIP Switch.
6. Serial Port to the UPS (COM1)
7. DC Supply (9 VDC or 9-36 VDC supply, depending on model), from a UPS-backed socket.



Figure 7.6 SNMP Adapter

RCCMD - Remote Console Command module for a multi-server shutdown.

The RCCMD modules are independent programs that may be activated on the computer that is running UPSMAN. This makes a shutdown call possible in any LAN and WAN environment, regardless of the network type or operating system.

7.3 PowerREPORTER™ management software

PowerREPORTER™ is a remote monitoring and management service which is a part of the premium power protection concept.

ThePowerREPORTER™ application:

- Provides affordable, continuous monitoring over mission-critical facilities and offers peace-of-mind by detecting and warning of any potential system problems before they become a crisis. I
- Acquires key performance parameters and productivity information in real-time to enable you to better understand machine performance and faster troubleshoot downtime events
- Gives total transparent information concerning all actions performed on the system, such as all critical status changes, coordination of equipment service, reporting of all alarms with priorities

Key features

- Redundant and secure communication
- Alarm acknowledgment
- Priority driven Management (with escalation)

Comprehensive management system

- Reception and management of alarm calls from UPS
- Storage of UPS Data in a database exportable in a CSV-format for easy handling in Excel
- Unlimited number of UPS that can be managed
- User administration with passwords and permission-level
- Administration of Log file
- Data logging with statistical analysis and diagnostics, report
- Visualization of the UPS data
 - Current status ("single" and "parallel" operation)
 - Measured values for single or three phase
 - Recording function including graphs with zooming capabilities for selected measured values
 - Display of event log file
 - Display of UPS Parameters
 - Web Server functionality, for data access from any Web Browser

7.3.1 Relay Interface Board

The Relay Interface Board provides volt-free alarm and status outputs that can be connected to a remote panel.

The board is contained in an ABS box which is fitted to the UPS back panel and connected to the 9-pin D-type connector on the back of the UPS by means of the supplied 0.6m ribbon cable.

The box cover is held in place by moulded clips and can be easily removed to provide access to the output terminal connectors.

Three relays are contained on the Interface Board which operate under the following conditions (see paragraph 3.3.2).

1. UPS on Mains / Battery
2. General UPS fault detected
3. Low battery. UPS has been operating on battery power and remaining autonomy time is low.

All relay contacts are rated at 150Vdc / 125Vac and 1A.

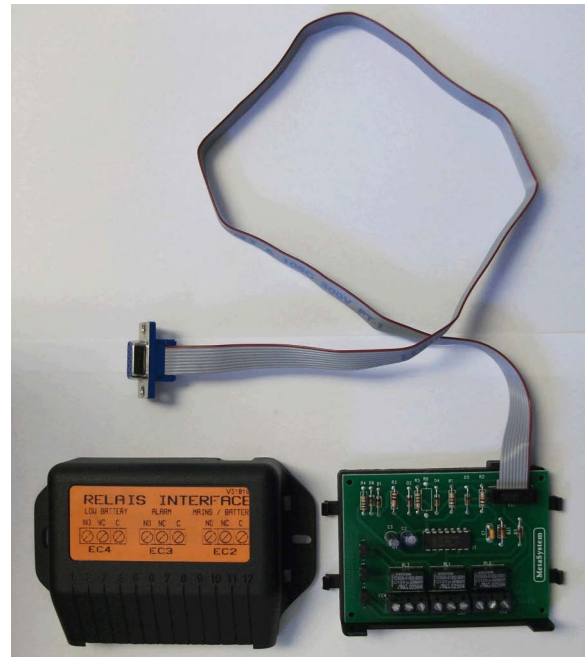

Figure 7.7 Relay Board Assembly

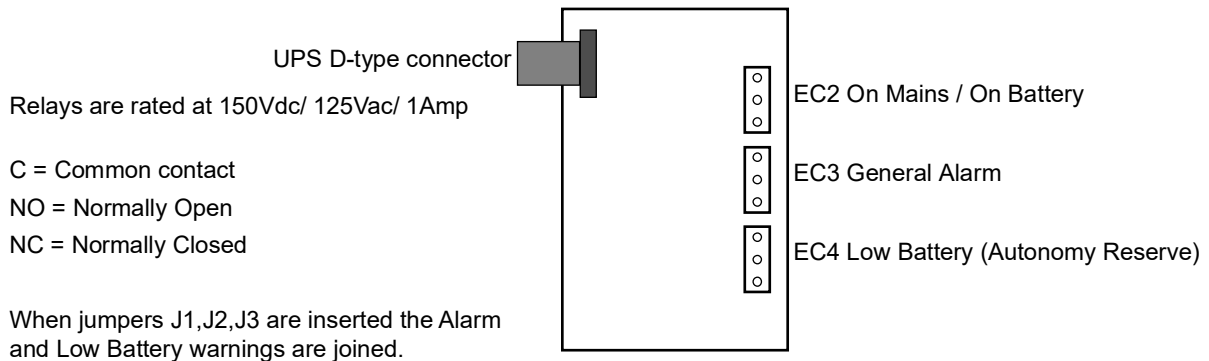

Figure 7.8 Relay Interface Board

8

Specifications

8.1 Construction Features

UPS Model Range	MINIpowerPLUS 5000				MINIpowerPLUS 10000				
	1250	2500	3750	5000	5000/2	6250/2	7500/2	8750/2	10000/2
Weight UPS Cabinet (Kg.)	23.5	34	43	53	24+50	26.5	29	31.5	34
Weight Battery Cabinet (Kg.)					50	57.5	65	72.5	380
Size (mm) (WxDxH)	Tower: 270 x 475 x 570 19" Rack: 483.5 x 600 x 266 (6U)				270 x 475 x 570 x 2 cabinets				
Technology	PWM high frequency both for input stage and output stage. Microprocessor control logic								
Expandability	Optional upgrading to configurations with higher power by fitting one or more extra power modules inside the same cabinet, up to a maximum of 4. Optional upgrading of autonomy by fitting extra batteries inside, up to a maximum of 4 sets of 3, 12V, 9Ah batteries				Optional upgrading to configurations with higher power by fitting one or more extra power modules inside the same cabinet, up to a maximum of 8. Optional upgrading of autonomy by fitting extra batteries inside, up to a maximum of 10 sets of 3, 12V, 9Ah batteries.				
Expandability	Optional battery cabinets can be connected, with a capacity of max 10 sets of 3, 12V, 9Ah batteries								
Computer Interface	Output with 9-pin male, SELV insulated connector. Standard serial RS232 for interfacing with personal computer using diagnostics software. Output with 9pin, female, SELV insulated, connector								
Remote Control	Output with 9-pin male, SELV insulated connector for connection to optional remote control. Optional scheduling of UPS switch ON/OFF and display of main UPS signals.								
Protection	Electronic protection against overloads, short circuits and excessive battery discharge. Operation blocked at end of autonomy. Inrush limitation when switching on. Sensor for correct neutral connection. Back-feed protection (electrical insulation for the safety of the input plug when running in battery mode). EPO contact (emergency power off)								
Synchronised Bypass	Automatic static and manual (optional). Intervenes in case of overload and operating anomaly.								

8.2 Environmental

UPS Model Range	MINIpowerPLUS 5000				MINIpowerPLUS 10000				
	1250	2500	3750	5000	5000/2	6250/2	7500/2	8750/2	10000/2
Storage Altitude	10.000 metres								
Storage Temperature	-20°C to +50°C								
Operating Temperature	0°C to +40°C								
Relative Humidity	20-80% non-condensing								
Protection	IP 21 (IEC529)								
Audible Noise	< 40dBA at 1 metre								

8.3 Electrical Input

UPS Model Range	MINIpowerPLUS 5000				MINIpowerPLUS 10000				
	1250	2500	3750	5000	5000/2	6250/2	7500/2	8750/2	10000/2
Nominal Input Voltage	230V								
Input Voltage Range	184V to 264V with nominal load 100V to 264V with 50% nominal load								
Frequency	50 or 60Hz \pm 2% auto-sensing and/or selected by operator								
Current (Nom.)	4.6A	8.9A	13.2A	17.7A	17.7A	22.4A	26.9A	31.25A	36.6A
Current (Max.)	5.75A	11.2A	16.6A	22.2A	22.2A	27.8A	33.25A	38.9A	44.5A
Current Distortion	<3% THD								
Power Factor	> 0.99 at 20% nominal load								
Inrush Current	100% of nominal current								
Phases	Single								
Line Fuse	25AF				32 + 32 AFF				
Battery Charger	0.8A rms (direct from mains)								

8.4 Output Waveform

UPS Model Range	MINIpowerPLUS 5000				MINIpowerPLUS 10000				
	1250	2500	3750	5000	5000/2	6250/2	7500/2	8750/2	10000/2
Mains Operation	Sine wave								
Battery Operation	Sine wave								
Topology	No break, on line UPS with passing neutral and double conversion								

8.5 Output When Running on Mains Power

UPS Model Range	MINIpowerPLUS 5000				MINIpowerPLUS 10000				
	1250	2500	3750	5000	5000/2	6250/2	7500/2	8750/2	10000/2
Nominal Output Voltage	230 V \pm 1%								
Nominal Output frequency	50 Hz / 60Hz synchronised (auto-sensing and/or as selected by operator)								
Output Current with linear load and 0.7 pf (A rms)	5.37	10.75	16.25	21.6	21.6	27.2	32.6	38	43.5
Crest Factor	3.5								
Output VA	1250	2500	3750	5000	5000	6250	7500	8750	10000
Output W with 0.7 pf linear/non-linear load	875	1750	2625	3500	3500	4375	5250	6125	7000
THD	< 0.5% with nominal load and < 1% with 0.7 pf nominal non-linear load								
Overload Capacity	300% for 1s, 200% for 5s and 150% for 30s without By-pass intervention								
Phases	Single								
AC-AC conversion efficiency with linear load pf=1 and charged batteries	80% with 50% load 85% with 75% load 92% with 100% load								

8.6 Output When Running on Battery Power

UPS Model Range	MINIpowerPLUS 5000				MINIpowerPLUS 10000				
	1250	2500	3750	5000	5000/2	6250/2	7500/2	8750/2	10000/2
Nominal Output Voltage	230 V \pm 1%								
Nominal Output frequency	50 Hz / 60Hz synchronised (auto-sensing and/or as selected by operator)								
Output VA	1250	2500	3750	5000	5000	6250	7500	8750	10000
Output W with 0.7 pf linear/non-linear load	875	1750	2625	3500	3500	4375	5250	6125	7000
THD	< 1%								
Overload Capacity	160% for 15s								
Allowable load pf	0.7-1.0								



WARNING: There is a danger of explosion should the batteries be replaced with the wrong type. Dispose of used batteries as per the instructions and precautions for their disposal on the battery label.

8.7 Battery Operation (MINIpowerPLUS 5000)

UPS Model Range	MINIpowerPLUS 5000											
	1250			2500			3750			5000		
Percentage load	50	80	100	50	80	100	50	80	100	50	80	100
*Standard autonomy	20	11	8	20	11	8	20	11	8	20	11	8
Recharge time to 90%	5 - 6 hours according to level of discharge											
Specifications and quantity of batteries	3 off 12V 9Ah, sealed, lead-acid, maintenance free batteries connected in series for each power module											
Reserve signals	32.2 V to 36V, programmable											
Minimum voltage for battery operation during discharge	27V to 31.5V with automatic selection depending on applied load, or as programmed by operator.											
*Approximate autonomy in minutes with fully charged batteries												

8.8 Battery Operation (MINIpowerPLUS 10000)

UPS Model Range	MINIpowerPLUS 10000														
	5000/2			6250/2			7500/2			8750/2			10000/2		
Percentage load	50	80	100	50	80	100	50	80	100	50	80	100	50	80	100
*Standard Autonomy	20	11	8	20	11	8	20	11	8	20	11	8	20	11	8
Recharge time to 90%	5 - 6 hours according to level of discharge														
Specifications and quantity of batteries	3 pcs 12V 9Ah, sealed, lead-acid, maintenance free batteries connected in series for each power module														
Reserve signals	32.2 V to 36V, programmable														
Minimum voltage for battery operation during discharge	27V to 31.5V with automatic selection depending on applied load, or as programmed by operator.														
*Approximate autonomy in minutes with fully charged batteries															

8.9 Bypass

UPS Model Range	MINIpowerPLUS 5000				MINIpowerPLUS 5000				
	1250	2500	3750	5000	5000/2	6250/2	7500/2	8750/2	10000/2
Type	Static and electromechanical								
Transfer time	0s								

8.10 Reference Standards

UPS Model Range	MINIpowerPLUS 5000				MINIpowerPLUS 5000				
	1250	2500	3750	5000	5000/2	6250/2	7500/2	8750/2	10000/2
Safety	Conforms to standard EN 62040-1-1								
Electromagnetic compatibility	Immunity: Conforms to standard EN 50091-2 (class A) Emissions: Conforms to standard EN 50091-2 (class B)								
Typical Performance	Conforms to standard EN 62040-3								