

# KOHLER®

UNINTERRUPTIBLE  
POWER



## KOHLER *PW* 6000

Medium to high power three-phase uninterruptible power supply

(160–500 kVA S2)

Technical Specification

**Document Control**

ISSUE	DATE	REVISION SUMMARY
TS_730_01	17/08/2023	Rebranding to KUP International Version

**Useful Contacts**

**UK**

www.kohler-ups.co.uk                      Kohler Uninterruptible Power web site  
ukservice.ups@kohler.com                  Service department – booking service, fault reporting etc.  
uktechnicalsupport.ups@kohler.com      Technical queries  
uksales.ups@kohler.com                     Hardware sales  
ukservicesales.ups@kohler.com           Extended warranty agreements etc

**IRELAND**

www.kohler-ups.ie                             Kohler Uninterruptible Power web site  
ieinfo.ups@kohler.com                      Service department, technical queries, hardware sales and extended warranty agreements

**SINGAPORE**

www.kohler-ups.sg                            Kohler Uninterruptible Power web site  
salesups.sg@kohler.com                    Hardware sales  
serviceups.sg@kohler.com                  Contract customer support, maintenance contracts renewals

All product, product specifications and data are subject to change without notice to improve reliability, function, design or otherwise. Kohler Uninterruptible Power has taken every precaution to produce an accurate, complete and easy to understand specification document and will assume no responsibility nor liability for direct, indirect or accidental personal or material damage due to any misinterpretation of, or accidental errors, in this manual.

© 2023 Kohler Uninterruptible Power

This manual may not be copied or reproduced without written permission of Kohler Uninterruptible Power

## KOHLER PW 6000 S2 DESCRIPTION

Continuous power availability is essential in today's dynamic IT and process-related environments. It is equally important that any installed power protection system is sufficiently resilient and adaptable to handle any changes brought about by the introduction of new server technologies, migration and centralization. Such demands are well met by the Kohler PW 6000 S2 UPS system, which provides the foundation for continuous power availability of network-critical infrastructures both in enterprise data centres, where business continuity has paramount importance, and in process control environments where manufacturing continuity is essential.

The Kohler PW 6000 S2 UPS, which is available over a model range of 160kVA to 500kVA, incorporates the latest technological developments in power engineering and represents a completely new generation of high power, three phase UPS systems. Its advanced double conversion VFI (Voltage and Frequency Independent) topology responds fully to both the highest availability and environmentally friendly requirements compliant with IEC 62040-3 (VFI-SS-111) standards.

Kohler PW 6000 S2 features innovations that combine to deliver the industry's best key values such as: enhanced power performance, parallel capability and connectivity's interaction.

Kohler Uninterruptible Power specialises in the installation and maintenance of Uninterruptible Power Systems; and this powerful UPS is just one example of our wide range of state-of-the-art power protection devices that will provide your critical equipment with a steady and reliable power supply for many years.

### Kohler PW 6000 S2 configurations

The Kohler PW 6000 S2 UPS can be configured to operate as a single, stand-alone UPS or several (up to 10) UPS cabinets can be connected in parallel to operate as a multi-module UPS system. A multi-module configuration is generally chosen either to increase a system's total power capacity or to provide module redundancy in order to keep the load supplied in the event of a module failure.

Due to its Decentralised Parallel Architecture (DPA) design, each Kohler PW 6000 S2 UPS can take the leadership role when operating in a multi-module system. This avoids a single point of failure in the parallel chain and ensures the highest level of power availability.

### System expansion

Most data centres present a low initial power demand which increases as the data centre grows to its full capacity; and it is essential that the installed power protection system can be expanded to meet a growing demand without compromising the existing load. This situation is easily managed in a Kohler PW 6000 S2 multi-module installation by adding an additional UPS cabinets to an existing system to increase the overall system capacity without having to temporarily transfer the load to the raw mains supply. This results in the highest level of power availability, interruption free.

### Key features

The highlights of this innovative UPS solution include its high reliability, upgrade ability, low operating costs and excellent electrical performance.

KEY FEATURES	
Compact size, small foot print	Space saving on expensive floor space
Flexible battery management	Advanced management of battery charging and preventive failure diagnostics avoids premature deterioration of battery life.
Best in class ac-ac efficiency, up to 96%	Energy-Operational cost savings (TCO)
Low input power factor (near unity)	Cost savings during installation and the entire life cycle (TCO)
Blade-server-friendly power; full power from 0.9 lead to 0.9 lag	No de-rating required with leading PF loads
Very low input current distortion THDi THDi = < 3.5% @ 100% load	Gen-set power and installation cost saving

## GENERAL SPECIFICATIONS

This Technical Specification provides detailed technical information on the mechanical, electrical and environmental performance of the Kohler PW 6000 S2 60-500 kVA model range, and is intended to support and provide answers to tender and end-user requirements.

MECHANICAL CHARACTERISTICS 160/200 kVA			
		160 kVA	200 kVA
Dimensions (WxHxD)	mm	850 x 1820 x 750	
Dimensions with elevation kit (WxHxD)	mm	850 x 1975 x 750	
Weight	kg	370	390
Colour		Black (RAL 9005)	
Batteries		Fitted in external enclosure	
Input and output power cable entry		Bottom	
Exhaust cooling air		Rear	



MECHANICAL CHARACTERISTICS 250/300 kVA			
		250 kVA	300 kVA
Dimensions (WxHxD)	mm	1100 x 1920 x 750	
Dimensions with elevation kit (WxHxD)	mm	1100 x 1975 x 750	
Weight	kg	540	580
Colour		Black (RAL 9005)	
Batteries		Fitted in external enclosure	
Input and output power cable entry		Bottom	
Exhaust cooling air		Rear	



MECHANICAL CHARACTERISTICS 400/500 kVA			
		400 kVA	500 kVA
Dimensions (WxHxD)	mm	1650 x 1994 x 850	
Dimensions with elevation kit (WxHxD)	mm	1650 x 2094 x 850	
Weight	kg	970	970
Colour		Black (RAL 9005)	
Batteries		Fitted in external enclosure	
Input and output power cable entry		Bottom	
Exhaust cooling air		Top	



MECHANICAL CHARACTERISTICS 400/500 kVA + Top Cable Entry (TCE) cabinet			
		400 kVA	500 kVA
Dimensions (WxHxD)	mm	2150 x 1994 x 850	
Dimensions with elevation kit (WxHxD)	mm	2150 x 2094 x 850	
Weight with TCE basic	kg	950+115	1000+115
Weight with TCE single input feed + cables	kg	950+245	1000+245
Weight with TCE dual input feed + cables	kg	950+285	1000+285
Colour		Black (RAL 9005)	
Batteries		Fitted in external enclosure	
Input power cable entry		Top	
Output power cable entry		Bottom	
Exhaust cooling air		None	



SYSTEM CHARACTERISTICS							
Topology		On-line, double conversion, Voltage and Frequency Independent (VFI)					
Technology		Second generation transformerless design					
Parallel configuration expansion		For added redundancy and/or capacity a parallel system can be extended to up to 10 modules on request					
Double conversion AC/AC efficiency with fully charged battery and linear load (PF = 1)	Load	160kVA	200kVA	250kVA	300kVA	400kVA	500kVA
	25%	94.7%	95.3%	94.5%	94.6%	95.2%	95.6%
	50%	95.5%	95.8%	95.3%	95.4%	96.0%	96.2%
	75%	95.4%	95.5%	95.0%	95.2%	95.8%	96.1%
	100%	95.1%	95.0%	94.5%	94.8%	95.6%	95.7%

INPUT CHARACTERISTICS							
		160 kVA	200 kVA	250 kVA	300 kVA	400 kVA	500 kVA
Input voltage	VAC	3x 380/220V+N, 3x 400/230V+N, 3x 415/240V+N					
Input voltage tolerance (ref to 3x400/230V) for Loads in %:	VAC	-23% +15%at <100% load -40% +15% at <80% load -30% +15%at <60% load				-10% +15% <100% load -20% +15%at <80% load -30% +15%<60% load	
Input frequency	Hz	35-70					
Inrush current	A	Limited by soft start					
Max. Input Power with rated output power and charged battery (pf=1.0)	kW	170	213	266	319	426	532
Max. Input Power with rated output power and charged battery (pf=1.0)	A	247	308	386	463	617	771
Max. Input Power with rated output power and charged battery (pf=1.0)	kW	187	234	293	351	468	585
Max. Input Power with rated output power and charged battery (pf=1.0)	A	271	339	424	509	679	848

BATTERY CHARACTERISTICS							
		160 kVA	200 kVA	250 kVA	300 kVA	400 kVA	500 kVA
Variable number of 12V battery blocks (only even numbers allowed)	No	44/50	50	44/50			
Max. battery charger current	A	50		60		100	
Battery type		VRLA or NiCd				VRLA, NiCd, Li-Ion	
Temperature controlled charger		Yes (temperature sensor optional)					
Battery charging curve		Ripple-free: IU (DIN 41773)					
Battery test		Automatic and periodic (adjustable)					

OUTPUT CHARACTERISTICS							
		160 kVA	200 kVA	250 kVA	300 kVA	400 kVA	500 kVA
Output rated power (@min 44 battery blocks)	kW	160	*200	250	300	400	500
Output current In (PF=1.0) (@min 44 battery blocks)	A	232	*290	361	433	577	722
Output rated voltage	VAC	3x 380/220 or 3x 400/230 or 3x 415/240					
Output voltage stability (Static)	%	< ± 1.0					
Output voltage stability (Dynamic)	%	< ±4 (with load step 0-100%, 100-0%)					
Output voltage distortion with linear load	%	< 2 with linear load					
Output voltage distortion with non-linear load	%	< 4 (EN 62040-3:2001)					
Output frequency	Hz	50 or 60					
Output frequency tolerance	%	±0.1 free-running, quartz oscillator ±2 or ±4 with mains synchronised (selectable)					
Frequency slew rate	Hz/s	1.0					
Output waveform		Sinewave with 0deg. phase imbalance @100% unbalanced load					
Permissible unbalanced load	%	100% (all 3 phases independently regulated)					
Overload capability on inverter at PF=1.0	%	110% load for 10 minutes 135% load for 1 minute				110% load for 30 mins 125% load for 10 mins 150% load for 1 min	
Inverter short circuit capability (x rated output)	A	1.9xIn 40ms	2.1xIn 40ms	2.0xIn 40ms	2.0xIn 40ms	2.2xIn 60ms	2.0xIn 60ms
Bypass short circuit capability		10x rated In for 10 ms					
Crest factor		3:1					
Bypass operation		At ±10.0% of nominal input voltage					
* With 50 battery blocks only							

OUTPUT POWER VERSUS COS $\phi$														
Module		Inductive (lagging COS $\phi$ )								Unity	Capacitive (leading COS $\phi$ )			
		0.6	0.65	0.7	0.75	0.8	0.85	0.9	0.95		1.0	0.95	0.9	0.85
160	kVA	160	160	160	160	160	160	160	160	160	160	160	156	154
	KW	96	104	112	120	128	136	144	152	160	152	144	132	122
200*	kVA	200	200	200	200	200	200	200	200	200	200	200	195	194
	KW	120	130	140	150	160	170	180	190	200	190	180	166	154
250	kVA	250	250	250	250	250	250	250	250	250	250	250	245	241
	KW	150	163	175	188	200	213	225	238	250	238	225	208	193
300	kVA	300	300	300	300	300	300	300	300	300	300	300	294	291
	KW	180	195	210	225	240	255	270	285	300	285	270	249	231
400	kVA	400	400	400	400	400	400	400	400	400	400	400	392	388
	KW	240	260	280	300	320	340	360	380	400	380	360	333	310
500	kVA	500	500	500	500	500	500	500	500	500	500	500	490	485
	KW	300	325	350	375	400	425	450	475	500	475	450	417	338

Vout=230Vac (L-N), 50 Hz, with minimum of 44 battery blocks (\*50 Battery blocks on 200kVA model)

STANDARDS	
Safety	EN62040-1-1: EN60950-1:2001/A11;/2004
Electromagnetic compatibility	IEC/EN 62040-2, IEC/EN61000-3-2, IEC/EN61000-6-2
Performance	EN 62040-3
Product certification	CE UKCA
Degree of protections	IP20

ENVIRONMENTAL CHARACTERISTICS							
		160 kVA	200 kVA	250 kVA	300 kVA	400 kVA	500 kVA
Audible noise at 1m @ 100 load (approximate values only)	dBA	83		85		80	
Ambient temperature for UPS	°C	0-40					
Battery temperature (recommended)	°C	20					
Battery storage time at 20°C		Maximum 6 months					
Fan assisted cooling air flow		Front entry, rear exit				Front entry top exit	
Airflow (25 - 30°C) with 100% non-linear load	m³/h	2500		3350		5370	6550
Heat dissipation with 100% non-linear load	W	10213	12766	15957	19149	18410	22470
Heat dissipation with 100% non-linear load	BTU/h	34856	43570	54462	65355	62832	76675
Heat dissipation without load	W	1500		2300		3050	3300
Relative air-humidity		Maximum 95% (non-condensing)					
Max altitude above sea level without derating		1000m (3300ft) without derating					
De-rating factor for use at altitudes above 1000m sea level according (IEC 62040-3)		Height above sea level (m/ft)			Derating factor for power		
		1500 / 4850			0.95		
		2000 / 6600			0.91		
		2500 / 8250			0.86		
		3000 / 9900			0.82		

COMMUNICATION OPTIONS	
Power Management Display (PMD)	LCD display and mimic diagram showing UPS operational status (Optional 7" TFT touch-screen display standard on 400/500kVA model)
Customer Interfaces: (Dry Ports)	Volt-free output interface provide status and alarm outputs for remote indication and interfacing with BMS systems. Together with customer inputs interface for connecting an Emergency Stop, On Generator status etc
RS-232 on Sub-D9 port (RS-232 on USB port)	For monitoring and integration in network management
RS-485 on RJ45 port	Remote monitoring system with graphical display (option)
RS-485 on RJ45 port	For multidrop purposes (option)
Slot for SNMP Card	Ethernet card for monitoring and integration in network management (option)
Slot for SNMP Card	Modem card for GSM remote monitoring (option)



## UPS CONTROL PANEL

A control panel located on the front of the cabinet provides the means for day-to-day UPS operation and performance monitoring. Two control panels are available; an LCD control panel is fitted as standard on modules up to 300 kVA, and a TFT touch screen control panel is used on 400/500 kVA models.

*Note: The TFT control panel is available as a fitted option on the lower rated models on request.*

From the UPS control panel the operator can:

- Stop and start the UPS module
- Transfer the UPS output (load) between the inverter and bypass
- Monitor the UPS input/output voltage, current and frequency
- Monitor the battery charge/discharge current and battery status
- Interact with monitored alarm and warning messages
- Configure the UPS operating parameters (service mode)
- Interrogate the UPS operating events and alarm history (service mode)
- Carry out diagnostic actions (service mode)

## LCD Control panel

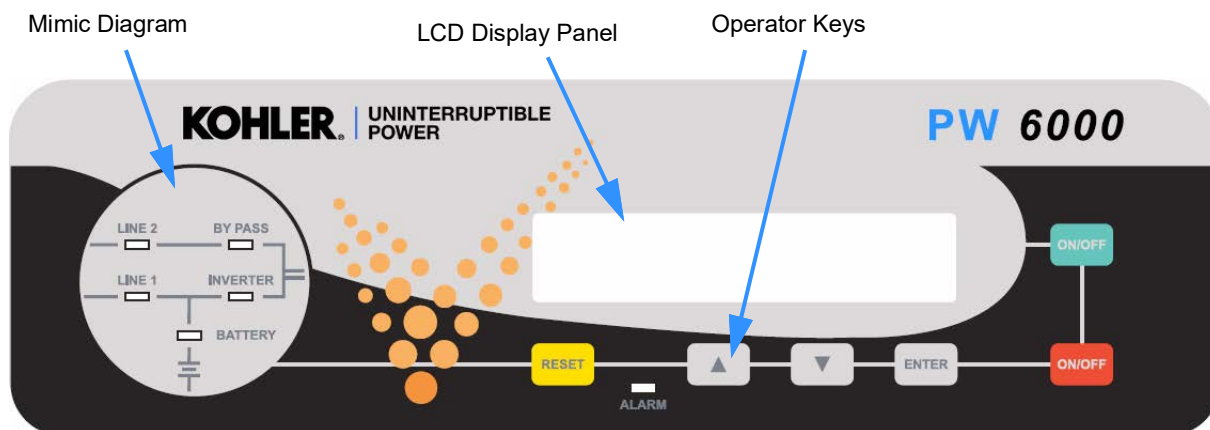

The user-friendly Power Management Display provides access to all monitoring information and operator controls.

### Mimic diagram

The mimic diagram contains multi-coloured LEDs that change between GREEN, RED and OFF to indicate the UPS operation and power flow status.

LEDs LINE 1 and LINE 2 indicate the availability of the input mains and bypass mains power supplies respectively, and are both GREEN during normal operation.

The INVERTER and BYPASS LEDs indicate which of the two power sources is providing the critical load supply. These LEDs illuminate GREEN to indicate which of the two is the active supply source.

The BATTERY LED indicator is a solid GREEN when the battery is being charged and flashes when the battery is discharging – e.g. when it is providing the output load power during a mains failure.

The ALARM LED, located at the lower-centre area of the Power Management Display, is a visual indication of any monitored internal or external alarm condition. When activated, it is accompanied by an audible alarm that can be cancelled by pressing the RESET button.

### LCD Display panel

The 2x 20 character multi-function LCD Display is menu-driven using the UP, DOWN and ENTER operator keys. It provides a simple communications interface that enables the operator to monitor important UPS operating parameters and alarm warnings, and carry out various control operations such as transferring the load between the inverter and bypass.

**LCD Display panel summary:**

- Displays the input and output voltage, current, frequency and power
- Displays an 'Event register' which stores a date/time stamped history of the 99 most recent alarms
- Enables battery run time monitoring
- Enables selection of commands such as UPS Start-up and Shut-down, Load transfer between inverter and bypass
- Provides diagnostic facilities and access to UPS adjustments and testing facilities (service mode only)

**Operator keys**

The operator keys allow the user to:

- Start and stop the UPS and transfer the load between inverter and bypass
- Set operating parameters and adjustments via the menu driven LCD display
- Select the UPS operating voltages, currents, frequencies and other values on the LCD display

There are two ON/OFF keys located on the control panel. In order to prevent inadvertent operation, both keys must be pressed simultaneously in order to turn the UPS OFF or ON.

**TFT Control panel**

The TFT control panel has a microprocessor-based touch-screen display which offers simple operation. When the UPS is energised the display runs through an initialisation process for several seconds and then automatically turns on, displaying the default mimic diagram screen. The screen's back-light turns off after three minutes of inactivity and turns back on when the screen is next touched.

**Default mimic display**

A UPS mimic diagram is displayed on the default screen and shows the power flow through the UPS module and indicates its operating status – in either single cabinet or multi-cabinet configuration. This screen can be accessed from any other screen by pressing the MIMIC icon in the display header bar.

The functional status of each block is identified by its line colour, as shown below.

- Green – In operation
- White – Inactive
- Yellow – Warning condition
- Red – Fault conditions

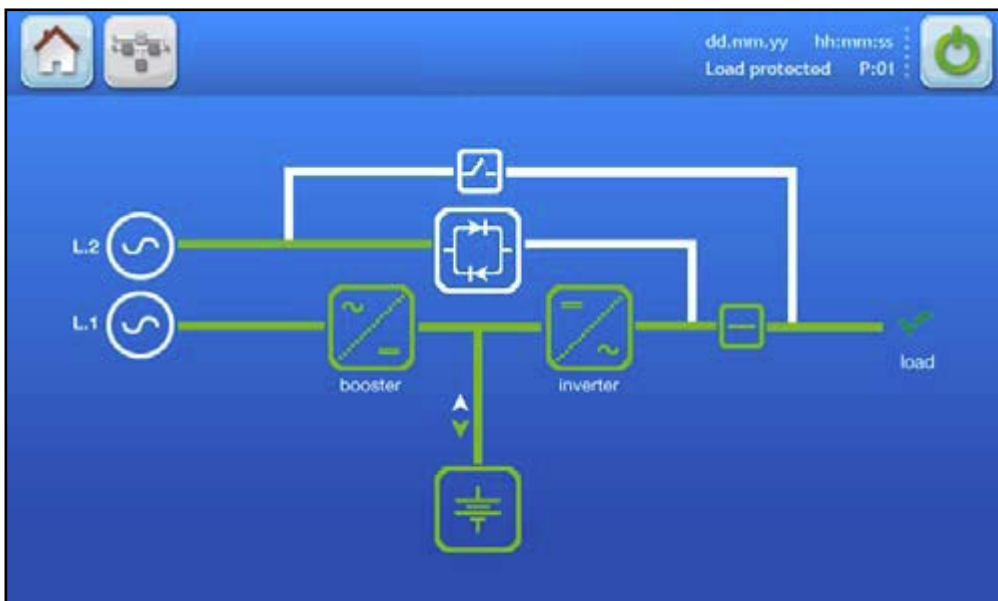

Three meters are included on the mimic display screen to indicate the rectifier, inverter, bypass and load operating parameters. The meter source is selected by touching the associated power block on the mimic display. The battery temperature and remaining autonomy time are also displayed.

**Display header bar**

A navigation and status bar is displayed in the header area of every screen.



<b>A</b>	<b>Home</b>	Accesses the HOME screen.
<b>B</b>	<b>Mimic diagram</b>	Accesses the MIMIC diagram screen.
<b>C</b>	<b>Warning</b>	The warning symbol is only visible in the presence of an alarm or monitored events. Touching this icon will silence the audible alarm and open the EVENTS screen.
<b>D</b>	<b>Date</b>	Current date indication. Set in the user menu and used to date-stamp the alarms/events log.
<b>E</b>	<b>Time</b>	Current time indication. Set in the user menu and used to time-stamp the alarms/events log.
<b>F</b>	<b>ON/OFF</b>	Turns the UPS module ON/OFF. Requires a confirmation message to be accepted.
<b>G</b>	<b>UPS number</b>	Each UPS module is given a sequential number in a parallel system. The number shown here is used to identify a particular module –e g. P01 indicates the UPS number 01. In a single module installation this would indicate S01.
<b>H</b>	<b>Load Status</b>	Displays whether or not the load is protected, when the user is in the module navigation level.

**Home screen**

The home screen is accessed by pressing the HOME icon on the display header bar on any screen and contains six icons that provide access to subordinate control and set-up function screens.



<b>A</b>	<b>Events</b>	Displays a list of recently occurred events with date, time, event name, description and sequential ID number. As a default the most recent appears on top.
<b>B</b>	<b>Measures</b>	This item displays a full set of measurements for each functional block of the UPS (detailed below).
<b>C</b>	<b>Command</b>	In this menu, the user can change the operating mode of the UPS. Once the command is executed, the user is immediately directed to the mimic diagram where the new status of the UPS is indicated (detailed below).
<b>D</b>	<b>UPS Data</b>	Gives information regarding the manufacturing of the UPS.
<b>E</b>	<b>User</b>	Enables the adjustment of data such as date and time, automatic battery test, etc (detailed below).
<b>F</b>	<b>Service</b>	This password protect area enables the service technician to adjust several UPS parameters (detailed below).

## CUSTOMER INTERFACE FACILITIES

Each UPS cabinet is fitted with a communications interface board, as shown below, which enables various external monitoring and control applications to be connected to the UPS to satisfy particular site requirements.

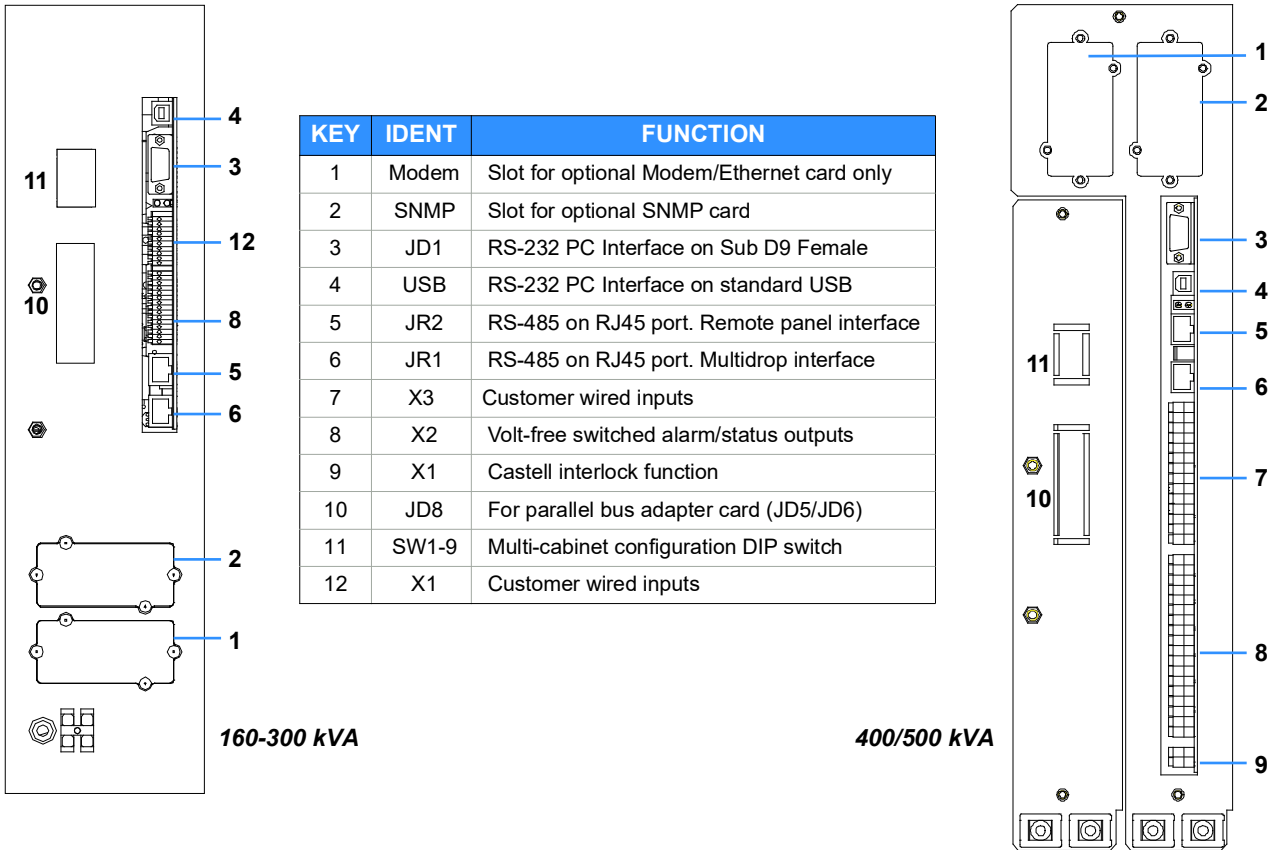

### RS-232 and USB – Computer serial interface

An RS-232 serial interface is available through a Sub D-9-pin female socket (JD1) and a standard USB port.

JD1 provides an intelligent RS-232 serial port which, when used in conjunction with suitable software, allows continuous monitoring of the input mains voltage and UPS status, and displays various status messages if there any UPS system changes. JD1 can be connected using a standard computer serial communications cable with a maximum length of the RS-232 cable is 15m.

The USB port is connected in parallel with JD1 and outputs the same data stream.

### RS-485 Interface for multidrop

‘Multidrop’ is an optional feature that is only applicable in a multi-module UPS system. It allows the communications interface board in the ‘master’ UPS cabinet to collect data and messages from those in the ‘slave’ cabinets. The received data is then processed at a centralised point on the ‘master’ communications interface board and then output as a single data stream on the RS-232 port (JD1), USB port, and also transmitted to the SNMP card if inserted in the relevant card-slot.

The multidrop output data stream can be connected to a computer which, using suitable software, can then display the operating parameters and status at both ‘system’ level and for each individual UPS module.

Multidrop is implemented by connecting a purpose-designed cable between JR2 (RJ45) on the communications interface board in every module. If this feature is requested, the commissioning engineer will install the required kit of parts and test the system to ensure it is fully functional as part of the UPS commissioning procedure.

### Dry ports – external wired input/output connections

A range of optional, hard-wired, input/output control and monitoring facilities can be connected to volt-free (dry port) terminals. The external connections are made to Phoenix spring terminal blocks (annotated X1, X2, X3) using 0.2 mm<sup>2</sup> to 1.5 mm<sup>2</sup> cables.

All voltage-free contacts are rated at 60VAC/500mA

### 160-300 kVA Model interface connections

	Terminal	Contact	Signal	Display	Function
X1	X1/10	Gnd	Gnd		+12 Vdc Power source (max 200 mA)
	X1/9	In	+12 Vdc		
	X1/8	Gnd	Gnd		REMOTE SHUTDOWN (Do not remove the factory-fitted bridge if this feature is not used)
	X1/7	In	+12 Vdc		
	X1/6	Gnd	Gnd		Battery Temperature Sensing (If connected this input is battery temperature dependent)
	X1/5	In	+3.3 Vdc		
	X1/4	Gnd	Gnd		Customer Specific Input (1) (Function on request))
	X1/3	In	+12 Vdc		
	X1/2	Out	Gnd		Customer Specific Input (2) (Default NC = Generator on line)
	X1/1	Gnd	+12 Vdc		
X2	X2/15	Com	Alarm	COMMON ALARM	Common
	X2/14	NC			No Alarm Condition
	X2/13	NO			Common (System) Alarm active
	X2/12	Com	Status	LOAD ON MAINS	Common
	X2/11	NC			Load not On Bypass
	X2/10	NO			Load on Bypass (Mains) active
	X2/9	Com	Alarm	BATT LOW	Common
	X2/8	NC			Battery OK
	X2/7	NO			Battery Low active
	X2/6	Com	Status	LOAD ON INV	Common
	X2/5	NC			Load not On Inverter
	X2/4	NO			Load on Inverter active
	X2/3	Com	Alarm	MAINS OK	Common
	X2/2	NC			Mains not present
	X2/1	NO			Mains present

**400/500 kVA Models interface connections**

All voltage-free contacts are rated at 250 Vac/8A, 30 Vdc/8A, 110 Vdc/0.3A, 220 Vdc/0.12A.

	Terminal	Contact	Signal	Display	Function
X3	X3/14	Gnd	Gnd		Battery Temperature Sensing (If connected this input is battery temperature dependent)
	X3/13	In	+3.3 Vdc		
	X3/12	Gnd	Gnd	GENERATOR OPER ON	Customer Specific Input (1) (Default NC = Generator on line)
	X3/11	In	+12 Vdc		
	X3/10	Gnd	Gnd	EXTERNAL O/P BREAKER	When used, both the external output breaker and internal IA2 have to be either open or closed in order to isolate or connect the UPS. Display: PARALLEL_SW_OPEN or PARALLEL_SW_CLOSED
	X3/9	In	+12 Vdc		
	X3/8	Gnd	Gnd	EXT MAN BYP	External Manual Bypass (Default NC = External bypass closed)
	X3/7	In	+12 Vdc		
	X3/6	Out	+12 Vdc		+12 Vdc Power source (max 200 mA)
	X3/5	Gnd	Gnd		
	X3/4	Gnd	Gnd	REMOTE SHUTDOWN	RSD Remote Shut Down Leave jumper JP5 in place if no Remote Shut Down input is connected
	X3/3	In	+12 Vdc		
	X3/2	–		REMOTE SHUTDOWN	RSD Remote Shut Down (For external switch) Max 250Vac/8A, 30Vdc/8A, 110Vdc/0.3A, 220Vdc/0.12A
X3/1	–				
X2	X2/18	Com			Common
	X2/17	NC			Auxiliary NO
	X2/16	NO			Auxiliary NC
	X2/15	Com	Alarm	COMMON ALARM	Common
	X2/14	NC			No Alarm Condition
	X2/13	NO			Common (System) Alarm active
	X2/12	Com	Status	LOAD ON MAINS	Common
	X2/11	NC			Load NOT On Bypass
	X2/10	NO			Load on Bypass (Mains) active
	X2/9	Com	Alarm	BATT LOW	Common
	X2/8	NC			Battery OK
	X2/7	NO			Battery Low active
	X2/6	Com	Status	LOAD ON INV	Common
	X2/5	NC			Load not On Inverter
	X2/4	NO			Load on Inverter active
	X2/3	Com	Alarm	MAINS OK	Common
	X2/2	NC			Mains not present
X2/1	NO	Mains Present			
X1	X1/2	230Vac	–	EXT MAN BYP	Castell Interlock Function External Manual Bypass closed (230 Vac 2AT)
	X1/1	N	–		

## SNMP Card slots

Simple Network Management Protocol (SNMP) is a world-wide, standardised communication protocol that uses a simple control language to monitor and control a network-connected device via an SNMP compatible application running within a standard web browser.

The Kohler PW 6000 S2 communications interface board contains two SNMP slots; one is designed to house a Modem/Ethernet SNMP adapter card and the other a Modem/GSM adapter. Alternatively, SNMP connectivity can also be implemented using an external SNMP adapter connected to the UPS RS-232 output.

An SNMP/Ethernet adapter contains an RJ-45 connector which allows the card to be connected to a computer network using a standard network cable. Once connected, the UPS-Management software agent, which is already installed in the SNMP adapter, then monitors the UPS operating parameters and makes the data available to the connected network. In a multi-module UPS system the SNMP interface can communicate 'system-wide' data or data for an individual UPS module.

The SNMP card enables event/alarm emails, server shut down (with optional licenses) and other tasks. The SNMP card can also be integrated with BMS software over a local area network (LAN) for SNMP or Modbus information over IP. An optional card enables Modbus over RS-485.

SNMP communication can also be implemented using an external SNMP adapter connected to the communications interface board serial port, as shown in the illustration below.

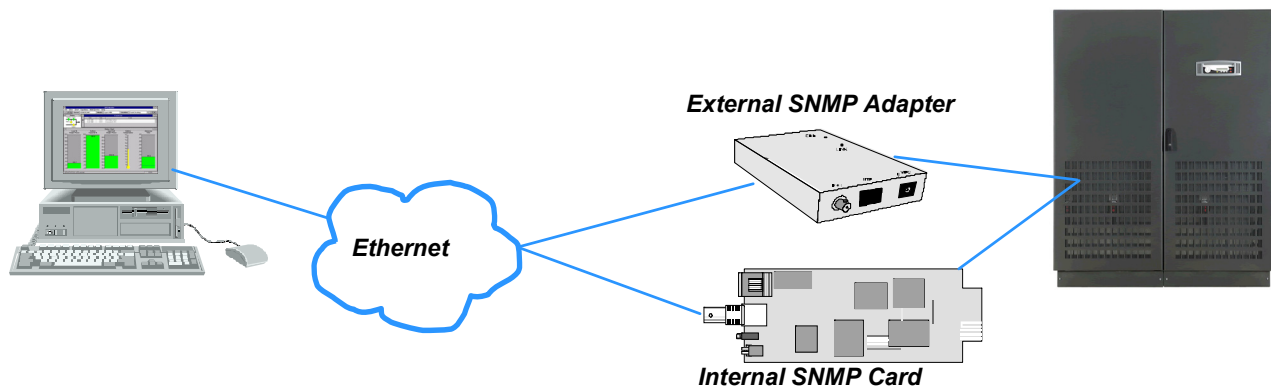

## OPTIONAL UPS MONITORING AND AUTOMATED CONTROL SOFTWARE

Three (optional) monitoring systems are available for use with the PowerWAVE 6000 S2 UPS system:

- SNMP – can be used for monitoring and controlled UPS shutdown
- WAVEMON – can be used for monitoring and controlled UPS shutdown
- PowerREPORTER – can be used to automatically email details of monitored parameters and alarm events to Kohler Uninterruptible Power Ltd for appropriate service support response

### SNMP monitoring software

The SNMP adapter described above requires a PC with terminal connections and, for normal operation, at least one Ethernet network connection. It also requires that the network operating system in use is SNMP-compatible.

### WAVEMON UPS monitoring and control software

WAVEMON is a bespoke software package which features both UPS monitoring and automatic UPS/server shutdown facilities. The package is installed on a local PC and communicates with the UPS via USB or an RS-232 serial cable. WAVEMON is only required when an SNMP card or adapter box is not purchased and it is designed to operate in conjunction with many of the systems supplied by Kohler Uninterruptible Power Ltd

- The main features of WAVEMON are:
- On-screen autonomy time/battery time countdown



- On-screen server log-off and shutdown procedure
- Time and date stamp event log
- Extensive logging of all UPS activity and power quality data
- Permits alarm warnings to be monitored remotely via email
- Scheduled UPS service mode and other systems status
- Graphical user interface for Windows-compatible platforms
- Automatic unattended local shutdown
- Special modules for MS-Office software to close and save open documents
- Compatible with all optional modules like UPSDIALER, SNMP adaptors, temperature sensors, etc.

### **Functional description**

WAVEMON is a client/server software application for networks and local workstations. In general, it consists of two parts: the server module of the UPS management software is UPSMAN, which communicates with the UPS via an RS-232/USB interface. Running as a background application, UPSMAN collects and interprets the messages received from the UPS and places them at the disposal of the client module UPSMON, as well as any connected SNMP-based instrumentation and control system.

If UPSMAN detects voltage variations or a power failure, it can execute various 'system event' routines, by means of which, for example, the server is switched off or a warning/alarm is sent to the connected users. These 'system event' routines are a part of the management software and can be configured in to suit local application requirements.

The software of your PowerWAVE 6000 S2 UPS unit can be integrated into a network in two ways:

1. By the server which is supplied by the UPS itself and has been integrated into the network. In most cases this server is used as a sub-agent and you only need the WAVEMON software (without an SNMP adapter). You will also need to establish an RS-232/USB connection between the UPS and computer/server.
2. In many cases the use of what is referred to as an 'SNMP adapter' is to be preferred in order to integrate the UPS into the network. In this case up to 50 computers can be shut down in one RCCMD environment. RCCMD (remote console command) is an additional software module that is used in order to execute a command (typically a shutdown command) in a remote system.

### **Licensing**

A licence is issued with every software serial number for use of what is known as the 'UPS service' on a single server in connection with one UPS and an unlimited number of connected WINDOWS workstations. For operation with two or more servers, a further licence is required for each additional server. In this case it is of no importance whether the UPS service on these servers is active or whether the server was stopped by a remote UPS service. The same applies to the use of RCCMD with the 'remote send/receive' modules for 'multi-server shutdown' under NT, UNIX and other operating systems. The service programs are generally supplied as single licences. In order to use a single CD-ROM for several 'multi-server shut-down' units you must acquire additional licence codes.

### **RCCMD Server shutdown**

In order that remote shutdown of servers can take place, initiated by the SNMP card or WAVEMON software, further licenses must be purchased. The license is for the RCCMD client (or listening) software that resides in each target server.

### **PowerREPORTER™ management software**

PowerREPORTER is a remote monitoring and management service which provides peace-of-mind protection by offering a continuous (24/7/365) watch over mission-critical facilities. Continuous monitoring is an affordable insurance policy to detect issues and provide an early warning before they develop into a crisis.

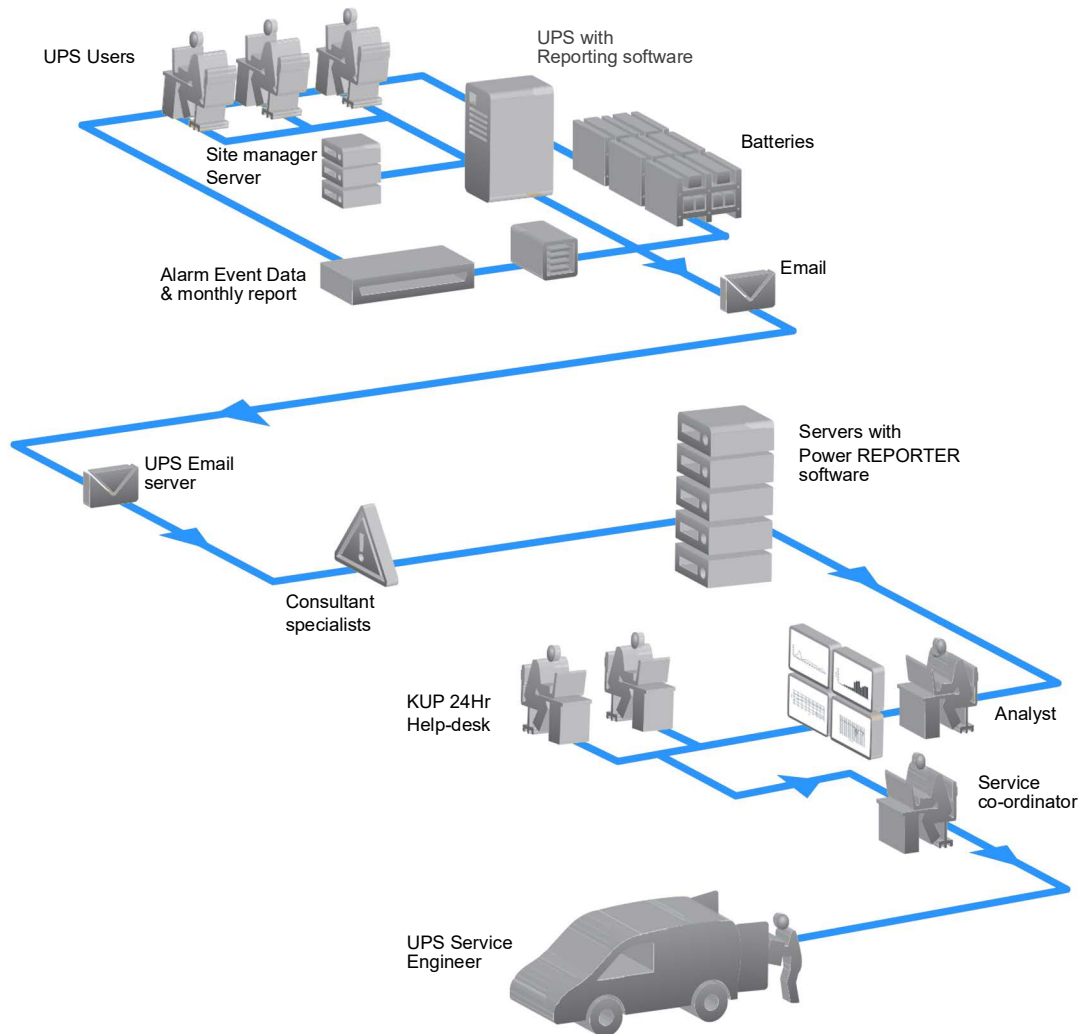

The main features and benefits offered by PowerREPORTER are:

- Real time email notification sent directly to KUP Service Centre in response to alarm/critical events
- Acquisition of key performance data and productivity information. Empowers you with the details needed to better understand machine performance and quickly troubleshoot downtime events
- Combined with a service contract, PowerREPORTER improves service levels. The engineer can determine if site attendance is necessary and bring relevant spare parts
- Monthly Status Report detailing trends and alarms
- Optional battery analysis and care service; PowerNSURE - measures battery voltage, temperature, impedance and prolongs battery service life through the application of battery charge equalization

**Functional description**

PowerREPORTER communicates constantly with your UPS system to automatically detect any error or alarm messages. If it encounters an incident, PowerREPORTER will automatically transmit a status message, via email, to the Kohler Uninterruptible Power Ltd Service Centre providing details relating to the identified fault, a snapshot of the UPS performance parameters and a device identification string.

The email automatically alerts the Service Centre personnel who then remotely diagnose the UPS incident and liaise with the company's field service team so that they can reach the facility with appropriate spare parts within the contracted service agreement time-frame.

**INSTALLATION PLANNING**

The following *guidelines* should be taken into account when planning a suitable UPS location and environment.

**Location considerations summary**

- The equipment must be installed and transported in a upright position
- The floor at the installed location and en-route from the off-loading point must be able to safely take the weight of the UPS and battery equipment
- The floor material where the UPS is to be located should be non-flammable
- Local fire protection standards must be respected
- Ensure that appropriate power supplies are available and that UPS cabling can be performed easily
- The location must be vibration free
- If the UPS is to be installed in bayed enclosures, partition walls must be installed.

**Environmental considerations summary**

- Avoid high ambient temperature, moisture and humidity  
Humidity (< 90% non-condensing) and temperature (+15°C / +25°C) are within prescribed limits
- A battery temperature of 20°C is recommended to achieve a long battery life
- Any prescribed air cooling flow must be available. Ensure the air conditioning system can provide a sufficient amount of air cooling to keep the room at, or below, the maximum desired temperature
- Ensure no dust or corrosive/explosive gases are present

**Clearances**

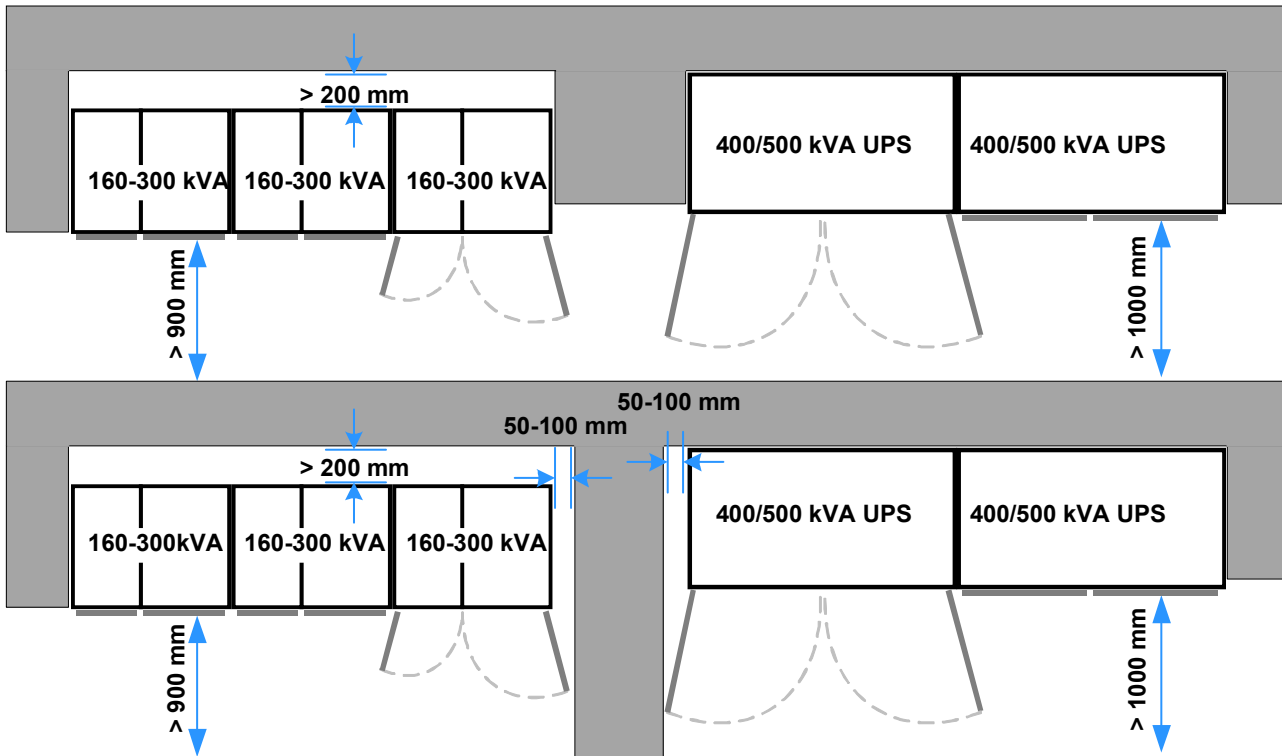

The above diagram illustrates the recommended clearances to be provided around the UPS cabinets.

**Notes:**

1. All cables enter the UPS via the bottom of the cabinet (an optional Top Cable Entry cabinet is available for the 400/500 kVA model) therefore no service/installation access is required from the rear or sides of the cabinets.
2. A minimum of 900-1000 mm clearance is required at the front of the cabinets for service access, and where possible this should be increased to allow safe passage in front of the UPS with the doors open.
3. In order to gain full access to some internal components it is necessary to open the doors by slightly more than 90°. If the cabinet is located adjacent to a partition or wall that extends beyond the front of the cabinet a clearance of 50-100 mm should be provided between the cabinet and the partition to allow the doors to open adequately, as illustrated in the lower diagram above. Note that there is no space required between cabinets.
4. The 160-300 kVA cabinets are force-cooled by rear-mounted extraction fans which require a minimum of 200 mm space at the rear of the cabinet to allow adequate exhaust air flow.
5. The 400/500 kVA cabinets are force-cooled by roof-mounted extraction fans. These cabinets do not require any space at the rear of the cabinet but a minimum free space of 400 mm is required above the cabinets.

## UPS POWER CABLING

All power cables are connected to a row of busbars located near the bottom of the UPS cabinet, as shown. An optional Top Entry cabinet is available for the 400/500 kVA models.

### UPS Module power connections

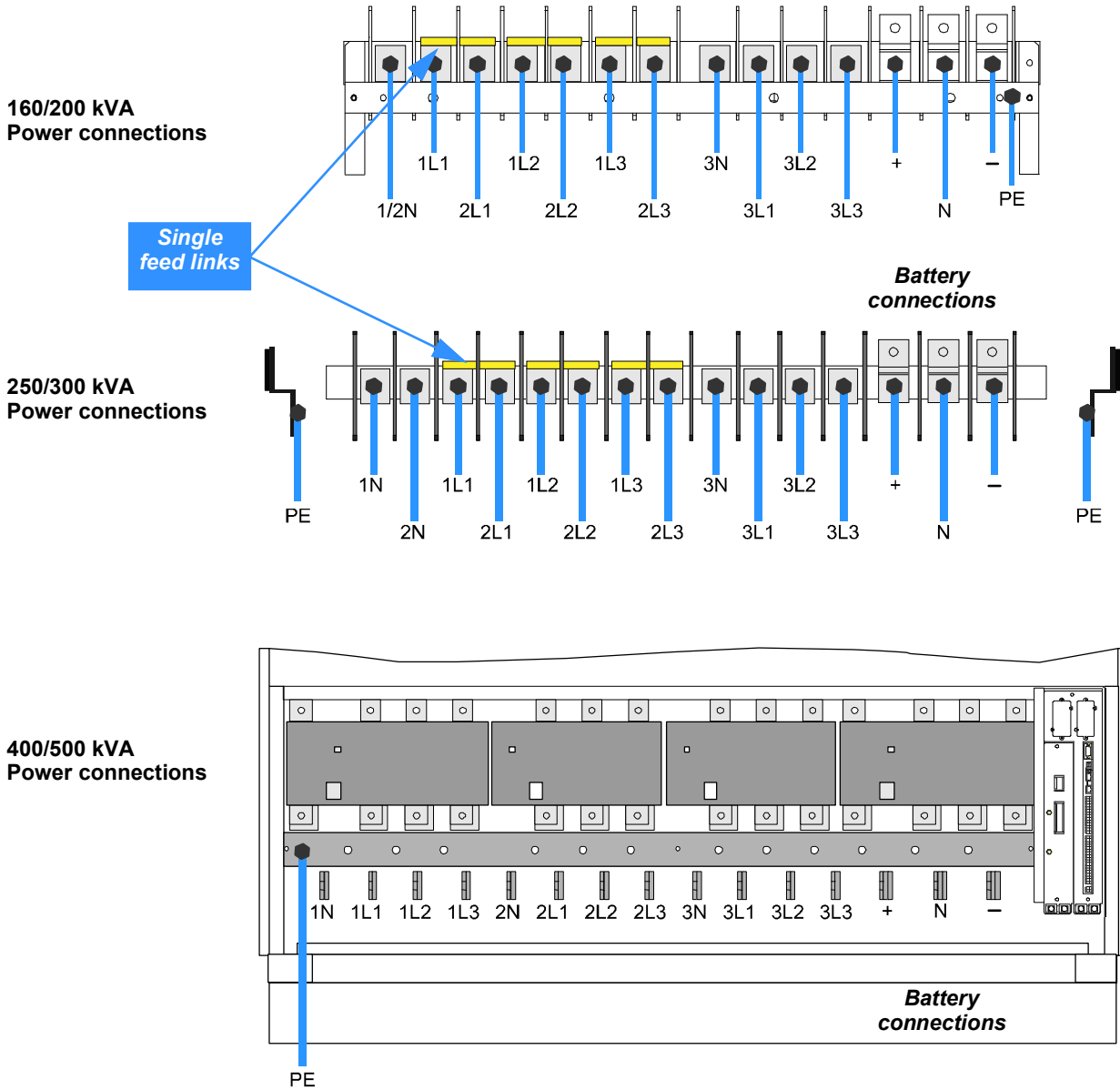

### Single/dual feed input

The UPS can be configured for a 'single feed' or 'dual feed' input connection. For a single feed input (standard), links are fitted between the bypass mains terminals and input mains terminals and the input mains cables therefore feed both supplies. The single feed links are removed for a dual feed input configuration and the bypass mains terminals are connected to a dedicated bypass mains power source.

*Note: Internal rear access is required to reconfigure the single/dual feed links in a 400/500 kVA model. If a 400/500 kVA UPS cabinet is to be placed against a wall, any configuration change must be completed before it is finally positioned.*

## FUSE & CABLE SIZING

It is the customer's responsibility to provide all the external fuses, isolators and cables that are required to connect the UPS inputs and outputs to their respective power distribution boards and battery system.

### Input/output supply protection

The UPS input/bypass mains supply cables must be connected via an LV-Distribution board in which suitable fuses or circuit breakers are installed to provide both overload protection and a means of isolating the UPS from the mains supply when required. Similarly, the UPS output cables should be connected to the load equipment via a load distribution panel containing suitable load protection devices. The input/output AC and DC cables and protective devices are identified in the diagrams on page 23 and page 24.

The fuse and cable sizing details given in the following tables are provided for guidance only:

- The UPS must be installed to prescribed IEC or local regulations (e.g. BS7671).
- The required DC cables and battery fuses are bespoke to the installation, depending on the battery type and quantity. Site-specific DC cable and fuse ratings can be provided by Kohler Uninterruptible Power on request.

### Cabling details for a single-feed input UPS cabinet

UPS CONNECTIONS (Single-feed input)									
UPS Module Rating (kVA)			160	200	250	300	400	500	
Cable A	1L1,1L2,1L3,1N, PE <sup>a</sup>	Max input demand <sup>b</sup>	271A	339A	424A	509A	679A	848A	
		Termination	5x M10					3x (5x M12)	
		Tightening Torque	50 Nm					84 Nm	
Fuse A	Agl/CB	3x	250A	350A	400A	500A	630A	800A	
Cable D	3L1,3L2,3L3,3N,PE <sup>a</sup>	Max rated output <sup>c</sup>	232A	290A	361A	433A	577A	722A	
		Termination	5x M10					3x (5x M12)	
		Tightening Torque	50 Nm					84 Nm	
Cable E	BATT+, BATT-, N, PE <sup>a</sup>	Max DC current	Bespoke to installation						
		Termination	4x M10					3x (4x M12)	
		Tightening Torque	50 Nm					84 Nm	
Fuse E	Agl/CB	3x	350A	450A	630A	630A	1000A	1250A	

a. Protective Earth (PE) cable must be sized in accordance with local and national regulations

b. Rating shown for 380V operation at low input voltage and batteries charging. See specification for 400/415V current ratings.

c. Rating shown for 380V operation at full load @ 1.0PF. See specification for 400/415V current ratings.

Single-feed input diagram

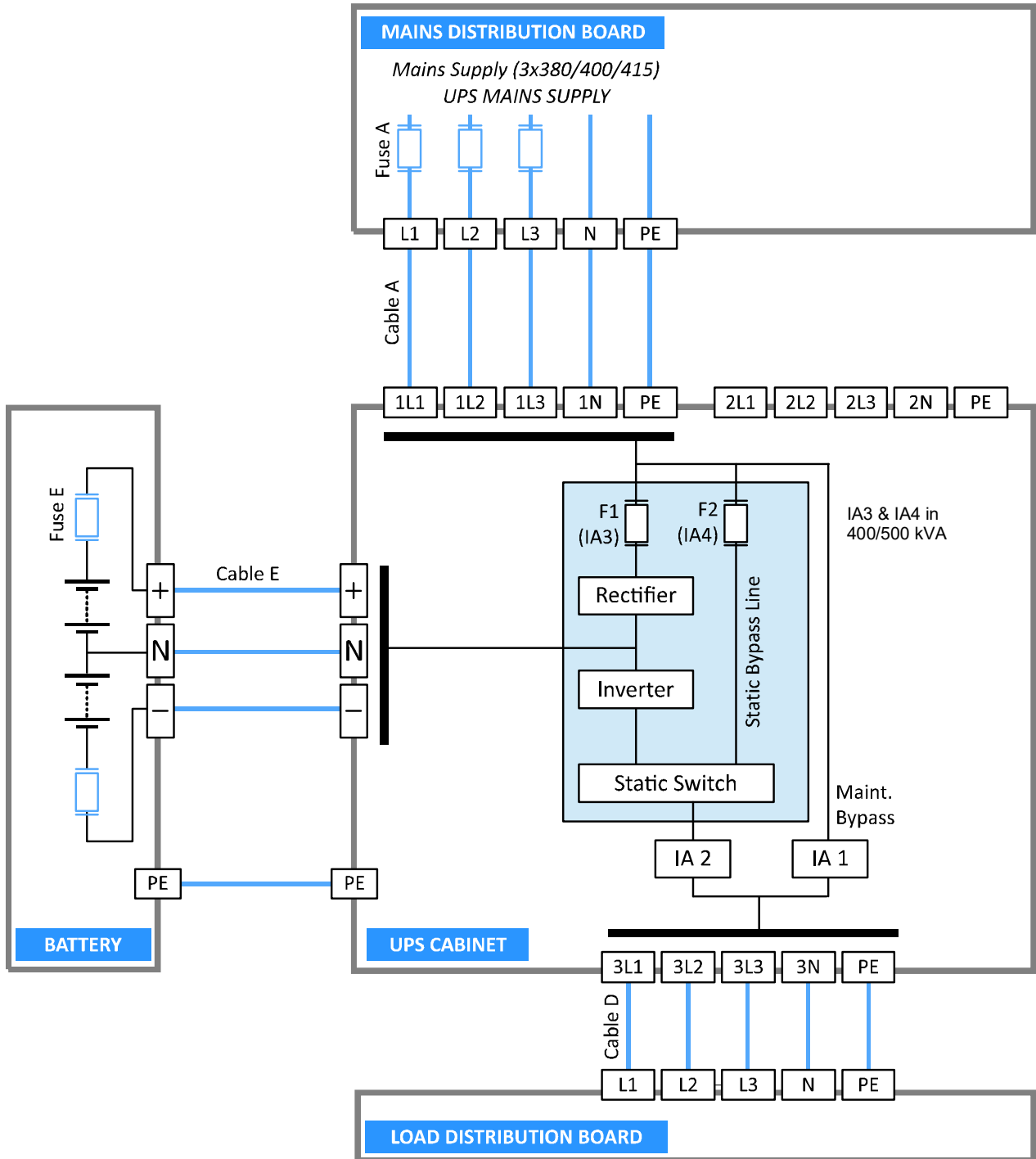

**Cabling details for a dual-feed input UPS cabinet**

UPS CONNECTIONS (Single-feed input)								
UPS Module Rating (kVA)			160	200	250	300	400	500
Cable B	1L1,1L2,1L3,1N, PE <sup>a</sup>	Max input demand <sup>b</sup>	271A	339A	424A	509A	660A	8A
		Termination	5x M10				3x (5x M12)	
		Tightening Torque	50 Nm				84 Nm	
Fuse B	Agl/CB	3x	250A	350A	400A	500A	630A	800A
Cable C	2L1,2L2,2L3,2N, PE <sup>a</sup>	Max bypass demand <sup>c</sup>	232A	290A	361A	433A	577A	722A
		Termination	5x M10				3x (5x M12)	
		Tightening Torque	50 Nm				84 Nm	
FuseC	Agl/CB	3x	250A	350A	400A	500A	630A	800A
Cable	3L1,3L2,3L3,3N,PE <sup>a</sup>	Max output demand <sup>c</sup>	232A	290A	361A	433A	577A	722A
		Termination	5x M10				3x (5x M12)	
		Tightening Torque	50 Nm				84 Nm	
Cable E	BATT+, BATT-, N, PE <sup>a</sup>	Max DC current	Bespoke to installation					
		Termination	4x M10				3x (4x M12)	
		Tightening Torque	50 Nm				84 Nm	
Fuse E	Agl/CB	3x	350A	450A	630A	630A	1000A	1250A

- a. Protective Earth (PE) cable must be sized in accordance with local and national regulations
- b. Rating shown for 380V operation at low input voltage and batteries charging. See specification for 400/415V current ratings.
- c. Rating shown for 380V operation at full load @ 1.0PF. See specification for 400/415V current ratings.



Dual-feed input diagram

