

# PowerWAVE 6000

(60-120 kVA S3)

## Technical Specification



## DOCUMENT CONTROL

ISSUE	DATE	REVISION SUMMARY
TS_660_01	27/2/2019	First issue (Kohler branding)
TS_660_02	22/03/2019	Standards details updated
TS_660_03	27/03/2019	Control Panel image updated

### Useful Contacts

<a href="http://www.kohler-ups.co.uk">www.kohler-ups.co.uk</a>	Kohler Uninterruptible Power Ltd. web site
<a href="mailto:ukservice.ups@kohler.com">ukservice.ups@kohler.com</a>	Service department – booking service, fault reporting etc.
<a href="mailto:uktechnicalsupport.ups@kohler.com">uktechnicalsupport.ups@kohler.com</a>	Technical queries
<a href="mailto:uksales.ups@kohler.com">uksales.ups@kohler.com</a>	Hardware sales
<a href="mailto:ukservicesales.ups@kohler.com">ukservicesales.ups@kohler.com</a>	Extended warranty agreements etc

All product, product specifications and data are subject to change without notice to improve reliability, function, design or otherwise. Kohler Uninterruptible Power Ltd. has taken every precaution to produce an accurate, complete and easy to understand specification document and will assume no responsibility nor liability for direct, indirect or accidental personal or material damage due to any misinterpretation of, or accidental errors, in this manual.

© 2019 Kohler Uninterruptible Power Ltd.

This manual may not be copied or reproduced without written permission of Kohler Uninterruptible Power Ltd.

## INTRODUCTION

Continuous power availability is essential in today's dynamic IT and process-related work environments. It is equally important that any installed power protection system is sufficiently resilient and adaptable to handle any requirement changes brought about by the introduction of new server technologies, migration and centralization.

Such demands are well met by the PowerWAVE 6000 S3 UPS system, which provides the foundation for continuous power availability of network-critical infrastructures both in enterprise data centres, where business continuity has paramount importance, and in process control environments, where manufacturing continuity is essential.

Offering maximum power protection, the PowerWAVE 6000 S3 has a small footprint and uses less energy than comparable products – thus delivering significant cost savings for the user. Its exceptional design meets all the modern requirements involved in building and operating energy-efficient and environmentally friendly centres.

The PowerWAVE 6000 S3 UPS is available over a model range of 60kVA to 120kVA and can be configured to operate as a single, stand-alone UPS or as a multi-module UPS system with up to ten UPS cabinets connected in parallel. A multi-module configuration is generally chosen either to increase the system's total power capacity or enhance the system's overall reliability by providing module redundancy.



**Key Point:** In a parallel system ALL the connected modules must be of the same output rating – e.g. it is not permissible to connect 60kVA and 120kVA cabinets together in a parallel system.

### Reliability and quality standards

Incorporating the latest technological developments in power engineering, the PowerWAVE 6000 S3 represents a completely new generation of high power three phase UPS systems; its advanced double conversion VFI (Voltage and Frequency Independent) topology responds fully to both the highest availability and environmentally friendly requirements compliant with IEC 62040-3 (VFI-SS-111) standards.

Kohler Uninterruptible Power Ltd. specialises in the installation and maintenance of Uninterruptible Power Systems; and this powerful UPS is just one example of our wide range of state-of-the-art power protection devices that will provide your critical equipment with a steady and reliable power supply for many years.

### Key features

High reliability, upgrade-ability, low operating costs and excellent electrical performance are just some of the highlights afforded by this innovative UPS solution.

Other key features include:

- Compact size – the small foot print offers saving on expensive floor space
- Battery charging management and failure diagnostics – avoids premature deterioration of battery life.
- Highly flexible battery configuration which supports the usage of 42-48 (12V) battery blocks in a string – allows battery optimization and reduces the need to oversize.
- Best in class ac-ac efficiency, up to 96% – reduces operational costs (TCO).
- Low input power factor (near unity) – results in cost savings during installation and the entire life cycle (TCO).
- Blade-server-friendly power – with full power available over a power factor ranging from 0.9 lead to 0.9 lag there is no requirement to de-rate the UPS when supplying leading power factor loads.
- Very low input current distortion THDi of  $\leq 4.0\%$  @ 100% load – reduces the power demanded from any connected standby generator resulting in reduced capital and installation costs.
- Front service access – all servicing is carried out from the front of the cabinet which reduces the time needed for maintenance.
- Cooling air exhaust through the top of the cabinet – no rear cabinet clearance is required for cooling air-flow, which allows the cabinet to be installed directly against a wall or partition which further reduces the installation footprint.
- System expandability – up to ten UPS cabinets can be connected as a parallel system. If fewer than ten cabinets are initially installed, additional cabinets can be added to the system at a later time without disrupting the load.
- Integrated maintenance bypass switch.

## GENERAL SPECIFICATIONS

MECHANICAL CHARACTERISTICS 60-120kVA (No Battery Enc.)					
Rating (kVA)		60	80	100	120
Dimensions (WxHxD)	mm	615 x 1954 x 480			
Dimensions with elevation kit (WxHxD)	mm	615 x 1978 x 480			
Weight (without batteries)	kg	198	206	228	230
Colour		Black (RAL 9005)			
Batteries		Fitted internally with optional external battery enclosure available			
Input and output power cable entry		Bottom with front access for connection			
Exhaust cooling air		Rear			

SYSTEM CHARACTERISTICS					
Topology		On-line, double conversion, Voltage and Frequency Independent (VFI)			
Technology		Second generation transformerless design			
Parallel configuration expansion		For added redundancy and/or capacity a parallel system can be extended to up to 10 modules on request			
Double conversion AC/AC efficiency. With fully charged battery and linear load (PF = 1) (Tolerance of $\pm 0.2\%$ )	Load	60	80	100	120
	100%	95.5%	95.5%	95.7%	95.7%
	75%	95.8%	95.8%	96.0%	96.0%
	50%	96.0%	96.0%	96.0%	96.0%
25%	95.0%	95.0%	95.0%	95.0%	
Eco mode efficiency	%	$\geq 99.0$			

INPUT CHARACTERISTICS		60	80	100	120
Input voltage	V	3x 380/220V+N, 3x 400/230V+N, 3x 415/240V+N			
Input voltage tolerance (ref to 3x400/230V) for Loads in %:	V	(-23% to +15%) 3x308/177 V to 3x460/264 V for <100 % load (-30% to +15%) 3x280/161 V to 3x460/264 V for < 80 % load (-40% to +15%) 3x240/138 V to 3x460/264 V for < 60 % load			
Input frequency	Hz	35-70			
Inrush current	A	Limited by soft start			
Max. Input Power with rated output power and charged battery (pf=1.0)	kW	64	85	105	126
Max. Input Current with rated output power and charged battery (pf=1.0) [@400/230V]	A	92	122	152	183
Max. Input Power with rated output power and discharged battery (pf=1.0)	kW	70	93	116	139
Max. Input Current with rated output power and discharged battery (pf=1.0) @400/230V	A	101	134	167	201
Input power factor (leading)		> 0.99 @100% load			
Input harmonic distortion (THDi) (%)		$\leq 4\%$ @100% load			

INPUT CHARACTERISTICS (Continued)		60	80	100	120
Rated short time withstand current		10kA for 1.5 seconds			
AC Power distribution system		TN-S, TN-C, TN-C-S, TT			
Required input connection		3 phases and neutral required			
Rated short time withstand current		10kA for 1.5 seconds			

BATTERY CHARACTERISTICS		60	80	100	120
Battery type		Maintenance-free VRLA, vented lead-acid, NiCd			
Variable number of 12V battery blocks	No.	42-48 Autonomies >60 min are only available for loads < 90%. For loads between 90-100%, the maximum allowed autonomy is 60 mins. For autonomy's less than 20 mins UPS supports 42-50 x12 V blocks			
Variable number of 1.2V NiCd cells	No.	420-480 Autonomies >60 min are only available for loads < 90%. For loads between 90-100%, the maximum allowed autonomy is 60 mins. For autonomy's less than 20 mins UPS supports 420-500 x1.2V cells			
Max. battery charger current	A	37	49	61	61
Max. battery charger power	kW	18	24	30	30
Battery float voltage (VRLA / NiCd)	VDC	2.25 / 1.40			
End of discharge voltage (VRLA / NiCd)	VDC	1.65 / 1.05			
Temperature controlled charger		Yes (temperature sensor optional)			
Ripple current (rms)	%	2% of the battery capacity			
Battery test		Automatic and periodic (adjustable)			

OUTPUT CHARACTERISTICS		60	80	100	120
Output rated power (@min 42 battery blocks)	kVA/ kW	60/60	80/80	100/100	120/120
Load power factor rated		1.0			
Output current (In) (PF=1.0) (@min 42 battery blocks)	A	87	116	145	174
Output rated voltage	V	3x 380/220 or 3x 400/230 or 3x 415/250			
Output waveform		Sinewave with 0deg. phase imbalance @100% unbalanced load			
Output voltage stability (normal/battery mode)	%	± 1.5 / ± 1.5			
Total harmonic distortion with 100% load operating in normal mode	%	< 2 with linear load			
Total harmonic distortion with 100% load operating in battery mode	%	< 2 with linear load			
Voltage imbalance and phase displacement with 100% load imbalance	°	0°			
Voltage transient and recovery time with 100% step load	%/ sec	< 4% (linear load)			
Output frequency	Hz	50 or 60			
Output frequency tolerance	%	±0.1 free-running, quartz oscillator ±2 or ±4 (selectable) with mains synchronised			

OUTPUT CHARACTERISTICS (Continued)		60	80	100	120
Frequency slew rate	Hz/s	1.0			
Max synch phase error	°	< 2° (referred to a 360° cycle)			
Permissible unbalanced load	%	100% (all 3 phases independently regulated)			
Overload capability on inverter	% / min	150% load for 30 seconds 125% load for 5 minutes 110% load for 20 minutes			
Inverter short circuit capability (x rated output for 40ms)	A	2.7x	2.0x	2.3x	1.8x
Fault clearing capability (100ms)	A	2x In for normal mode and battery mode			
Bypass short circuit capability	A	10x rated In for 10ms			
Crest factor		3:1			
Bypass operation	V	At ±15.0% of nominal input voltage			
* With 50 battery blocks only					

STATIC BYPASS		60	80	100	120
Transfer time	ms	< 1.0 Inverter to bypass < 5.0 bypass to inverter < 6.0 in Eco mode			
Rated current	A	87	116	145	174
Bypass mode fault clearing capability	A	10x In for 20ms (with recommended fuses fitted)			
Overload protection on bypass mode	% / min	150% load for 30 seconds 125% load for 5 minutes 110% load continuously			
Maintenance bypass		Fitted as standard			
Bypass protection fuses or circuit breaker		Not included			

ENVIRONMENTAL CHARACTERISTICS		60	80	100	120
Audible noise @ 100/50% load	dBA	< 65			< 69
Ambient temperature for UPS	°C	0-40			
Temperature for batteries (recommended)	°C	20			
Battery storage time (at 20°C)		Maximum 6 months			
Fan assisted cooling air flow		Front entry, top exit			
Heat dissipation with 100% linear load	W	2850	3800	4750	5700
	BTU/h	9730	12970	16220	19460
Heat dissipation without load	W	410	530	640	640
Relative air-humidity		≤ 95% (non-condensing)			
Max altitude above sea level without derating		1000m (3300ft) without derating			
De-rating factor for use at altitudes above 1000m sea level according (IEC 62040-3)		Height above sea level (m/ft) 1500 / 4850 2000 / 6600 2500 / 8250 3000 / 9900			

<b>STANDARDS</b>	
Safety	IEC/EN 62040-1
Electromagnetic compatibility	IEC/EN 62040-2
Performance	EN 62040-3:
Product certification	CE
Degree of protections	IP20
Manufacturing	ISO 9001:2008, ISO 14001:2004

<b>COMMUNICATION OPTIONS</b>	
Power Management Display (PMD)	LCD display and mimic diagram showing UPS operational status
Customer Interfaces: (Dry Ports)	Volt-free output interface provide status and alarm outputs for remote indication and interfacing with BMS systems. Together with customer inputs interface for connecting an Emergency Stop, On Generator status etc.
RS232 on Sub-D9 port	For monitoring and integration in network management
RS485 on RJ45 port	Remote monitoring system with graphical display (option)
RS485 on RJ45 port	For multidrop purposes (option)
Slot for SNMP Card	Ethernet card for monitoring and integration in network management (option)
Slot for SNMP Card	USB Port and relay card. Customer outputs



**POWERWAVE 6000 S3 USER CONTROLS**



A	IA1 – Maintenance bypass isolator
B	IA3 – Input supply isolator
C	IA4 – Bypass supply isolator
D	IA2 – UPS Output (parallel) isolator
E	Input/Output/Battery connections (behind cover)
F	Communications interface facilities
G	Cooling fan (extraction through roof)
H	UPS Control panel
I	Key-lockable door handle
J	Cooling air inlet mesh screen
K	Module mimic led indicators
L	Audio / Alarm reset key
M	Alarm led
N	Menu navigation keys
O	UPS ON/OFF keys
P	Power Management Display (PMD) LCD screen

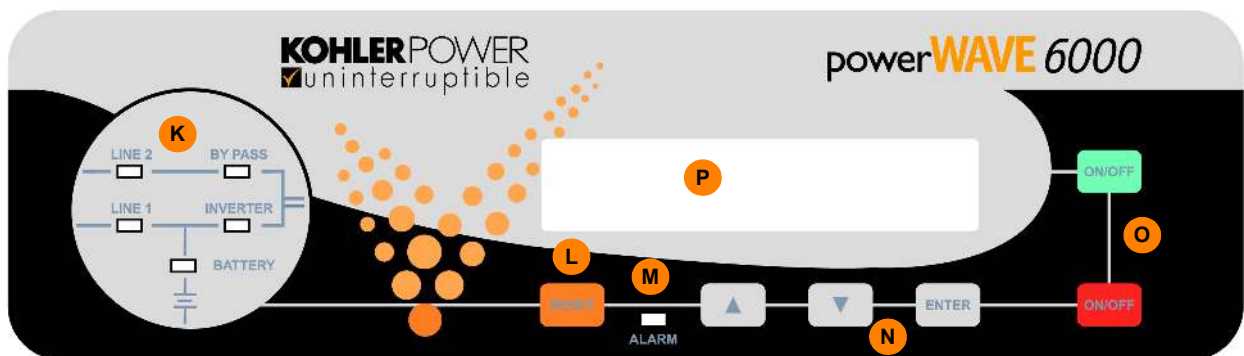



## UPS CONTROL PANEL

An LCD control panel located on the front of the cabinet provides the means for day-to-day UPS operation and performance monitoring.

From the UPS control panel the operator can:

- Stop and start the UPS module
- Transfer the UPS output (load) between the inverter and bypass
- Monitor the UPS input/output voltage, current and frequency
- Monitor the battery charge/discharge current and battery status
- Interact with monitored alarm and warning messages
- Configure the UPS operating parameters (service mode)
- Interrogate the UPS operating events and alarm history (service mode)
- Carry out diagnostic actions (service mode)

## Module mimic LED indicators

The module mimic LEDs change colour between GREEN, RED and OFF to indicate the operational status of key UPS stages and thereby serve to show the active power path through the UPS.

- LINE 1 (rectifier) and LINE 2 (bypass) LEDs indicate the availability of the input mains and bypass mains supplies
- INVERTER and BYPASS LEDs illuminate green to indicate which of the two sources is providing the load power
- BATTERY illuminates green when the battery is being charged and flashes when the battery is discharging – e.g. when supplying the load following a mains failure
- ALARM provides a visual indication that an internal or external alarm condition has been detected.

When activated, it is accompanied by an audible alarm

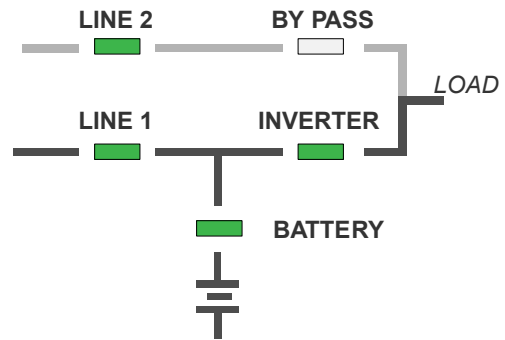

## LED Indication summary

INDICATOR	STATUS	INTERPRETATION
LINE 1	GREEN RED	Input mains available Input mains not available
LINE 2	GREEN RED	Bypass mains bypass OK Bypass mains not OK or not present
ALARM	OFF Flashing RED + buzzer RED	No alarm condition Alarm condition needs attention Alarm condition accepted (audible alarm has been reset)
INVERTER	GREEN RED OFF	Load on inverter Inverter fault Inverter not operating
BY-PASS	GREEN OFF	Load on bypass Bypass not operating
BATTERY	GREEN RED Flashing RED Flashing GREEN	Battery OK Battery fault or discharged Battery fuses blown On Battery mode (battery supply the load and discharging)

## Operator keys

The operator keys allow the user to:

- Set operating parameters and make adjustments via the menu-driven LCD display
- Start and stop the UPS, and transfer the load between inverter and bypass
- Select the UPS operating voltages, currents, frequencies and other parameters to monitor on the LCD display

### Key function summary

KEYS	FUNCTION
ON/OFF ON/OFF	Used to switch-on or switch-off the UPS
UP (▲)	Scroll upwards through a displayed menu
DOWN (▼)	Scroll downwards through a displayed menu
RESET	Cancels the audible alarm.
ENTER	Confirms (selects) a chosen menu item

### ON/OFF keys

The UPS can be switched ON or OFF by simultaneously pressing both ON/OFF keys on the UPS control panel. The requirement to press both buttons is to help avoid accidental operation.

During normal operation, pressing the two ON/OFF buttons simultaneously will immediately turn off the UPS.

- In a single module installation this will disconnect the UPS output unless the load is first transferred to the maintenance bypass
- In a parallel module system the UPS module will shutdown and its output will be disconnected from the parallel load bus. However, the load may or may-not transfer to bypass depending on whether or not the number of remaining live modules satisfies the system's redundancy – i.e. if there are a sufficient number of modules remaining to support the system load then the load will not be transferred.

To shut down all the modules in a parallel system you must press both ON/OFF buttons on every module.

### Reset key

If the module experiences a fault, or encounters an abnormal situation, the event is logged and displayed on the LCD display, the ALARM led turns red and an audible alarm sounds. Pressing the RESET button accepts the alarm and resets the audible warning but the ALARM led will remain illuminated if the fault condition still exists.

### Power Management Display (PMD)

The 2 x 20 character LCD Power management display simplifies communication with the UPS and provides a range of information concerning the module's operating status and configuration data, including:

- Event register
- Input and output voltage, current, frequency and power
- Battery run time
- Load transfer from inverter to bypass and vice-versa
- Diagnostic configuration, adjustments and testing (service mode)
- Menu navigation and selection is carried out using the UP, DOWN and ENTER keys

## CUSTOMER INTERFACE OPTIONS

### Introduction

Each UPS is fitted with a communication interface board which enables various external monitoring and control applications to be connected to the UPS system to satisfy a particular site's requirements.

Two leds (D) are located on the communications interface board to indicate its status:

- The green led indicates the UPS cabinet's master/slave status (only one cabinet can be 'master').
  - flashing twice/sec = interface is master (1st cabinet of a parallel system).
  - flashing once/sec = Interface is slave (2nd,.. 10th cabinet of a parallel system).
- The red led signifies a board malfunction and possibly needs replacement

A	SLOT 2 – for optional USB and Relay card. This card provides UPS/MAINS status monitoring via volt-free relay contacts. It also provides a USB port which can be used as an alternative RS232 output to communicate with a remote computer.
B	SLOT 1 – for optional SNMP card.
C	JD1 – RS232 Communications for computer interface.
D	Communications interface board operations status leds
E	X1 – Customer control inputs
F	SW2 – Multidrop configuration DIP switch
G	MULTIDROP – JR45 multidrop cable connection

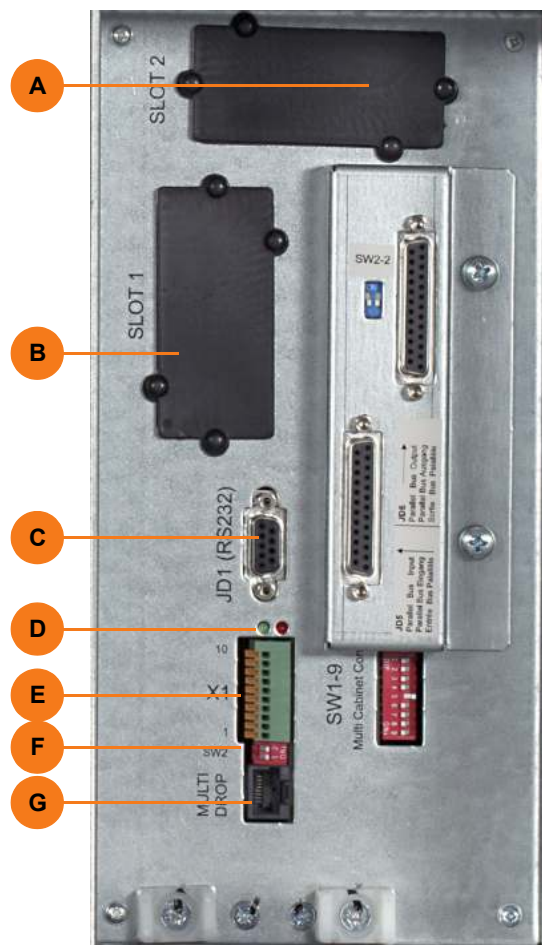

### Customer inputs (X1)

Terminal block X1 provides a range of standard input interfaces that can be used by the customer as required. All connections are made to Phoenix spring terminals using wires up to 1.5 mm<sup>2</sup>.

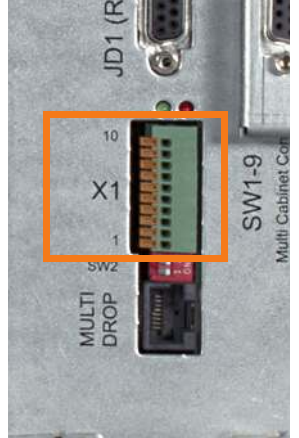
	Terminal	Contact	Signal	Function	
X1	X1/10	Gnd	Gnd	+12Vdc Power source (max 200mA)	
	X1/9	In	+12Vdc		
	X1/8	Gnd	Gnd	REMOTE SHUTDOWN (Emergency Power Off) (Do not remove the factory-fitted bridge if this feature is not used)	
	X1/7	In	+12Vdc		
	X1/6	Gnd	Gnd	BATTERY TEMPERATURE SENSING (If connected this input is battery temperature dependent)	
	X1/5	In	+3.3V		
	X1/4	Gnd	Gnd	CUSTOMER SPECIFIC INPUT (Function on request to be defined)	
	X1/3	In	+12Vdc		
	X1/2	Out	Gnd	GENERATOR OPERATION (NC = Generator on line)	
X1/1	Gnd	+12Vdc			

### Customer outputs (+USB)

The customer output interfaces are on an optional relay card which can be fitted to Slot 2 on the communications interface board. The relay card contains 5 relay-switched, volt-free changeover outputs that can be connected to the external site monitoring/ BMS facilities. The relays are rated at 60VAC and 500mA and the connections are made to Phoenix spring terminals using wires up to 1.5 mm<sup>2</sup>.

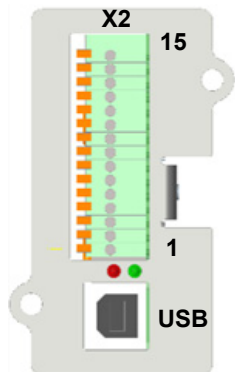
	Terminal	Contact	Signal	Display	Function	
X1	X2/15	Com	ALARM	COMMON_ALARM	Common	
	X2/14	N/C			No Alarm Condition	
	X2/13	N/O			Common Alarm (system)	
	X2/12	Com	MES-SAGE	LOAD_ON_MAINS	Common	
	X2/11	N/C			Load On Inverter	
	X2/10	N/O			Load On Bypass (mains)	
	X2/9	Com	ALARM	BATTERY_LOW	Common	
	X2/8	N/C			Battery OK	
	X2/7	N/O			Battery Low	
	X2/6	Com	MES-SAGE	LOAD_ON_INV	Common	
	X2/5	N/C			Load On Bypass (mains)	
	X2/4	N/O			Load On Inverter	
	X2/3	Com	ALARM	MAINS_OK	Common	
	X2/2	N/C			Mains Failure	
	X2/1	N/O			Mains Present	

### Serial RS232 Computer interface – USB & JD1 (Smart Port)

A serial RS 232 interface, which allows the UPS to be connected to a computer, is available through a standard 9-pin D-Type female socket (JD1) or via the USB port on the optional relay card fitted to Slot 2. Only one communication port can be active at a time and the priority is given to the USB port.

When appropriate power management software, such as WAVEMON, is installed, the computer can continuously monitor the input mains voltage and UPS status, and display a message in response to any UPS system changes.

#### USB Port

The USB port is compliant with USB 1.1 protocol and can be connected to a computer using the cable provided.

#### JD1 RS232 Port

JD1 is a standard 9-pin D-Type female socket which provides an intelligent RS-232 serial port. Note that the maximum length for the interconnecting RS232 cable is 15m.

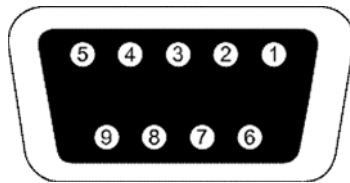

Pin	Signal	Description	I/O
2	TXD	Transmit to external device	Output
3	RXD	Receive from external device	Input
5	GND	Ground (tied to chassis)	Input



### RS485 Interface for multidrop

Multidrop cables are connected between the modules in a parallel system to enable the system and individual modules to be remotely monitored over Ethernet. The cables (supplied) are terminated with RJ45 plug connectors that fit into the multi-drop socket on the communications interface board. An RJ45 splitter plug (supplied with the fitting kit) is required when fitting the cables to the 'middle' cabinets.

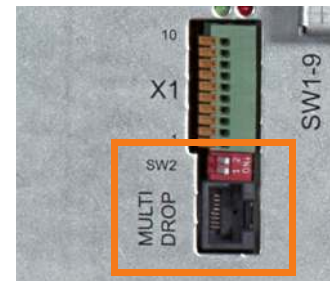

### SNMP Card slot

Simple Network Management Protocol (SNMP) is a world-wide, standardised communication protocol that can be used to monitor any network-connected device via a simple control language and display the results in an application running within a standard web browser.

The PowerWAVE 6000 S3 contains an SNMP slot (SLOT 1) which is designed to house a Modem/Ethernet SNMP adapter card. Alternatively, SNMP connectivity can also be implemented using an external SNMP adapter connected to the UPS RS232 output (JD1).

The SNMP/Ethernet adapter contains an RJ-45 connector which allows it to be connected to the network using a standard network cable. Once connected, the UPS-Management software agent, which is already installed in the SNMP adapter, then monitors the UPS operating parameters and communicates the operating data to the connected PC. In a multi-module UPS system the SNMP interface can communicate 'system-wide' data or data for an individual UPS module.

The SNMP card enables event/alarm emails, server shutdown (with optional licenses) and other tasks. The SNMP card can also be integrated with BMS software over a local area network (LAN) for SNMP or Modbus information over IP. An optional card enables Modbus comms over RS485.

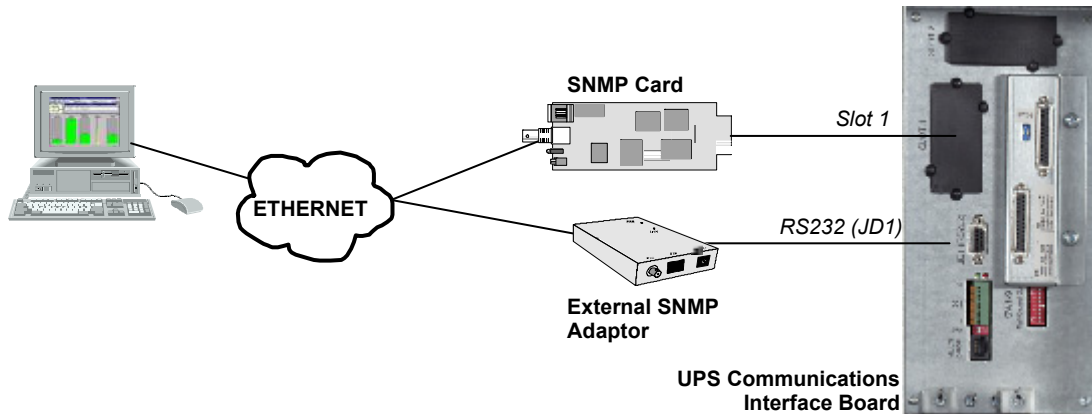

## WAVEMON SHUTDOWN AND MONITORING SOFTWARE (INSTEAD OF SNMP CARD)

WAVEMON is designed to operate in conjunction with many of the systems supplied by Kohler Uninterruptible Power Ltd. and features both UPS monitoring and automatic UPS/server shutdown facilities.

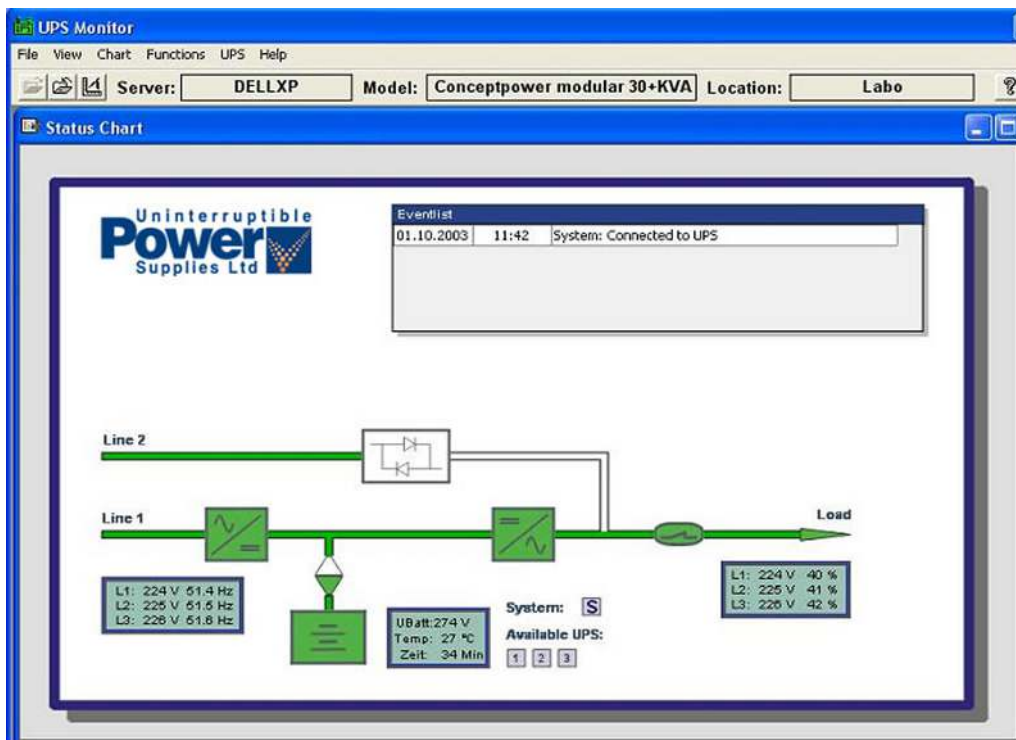

WAVEMON comprises a bespoke software package which is installed on a local PC and communicates with the UPS via the customer interface contacts (X1-X2), optional USB port or the standard RS232 port (JD1) using a serial cable of up to 15m in length. The facilities afforded by this software can be viewed as an alternative to that offered when using the SNMP adaptor card option, and it is only required when an SNMP card or adapter box is not purchased.



The main features of WAVEMON are:

- On-screen autonomy time/battery time countdown.
- On-screen server log-off and shutdown procedure.
- Time and date stamp event log.
- Extensive logging of all UPS activity and power quality data.
- Permits alarm warnings to be monitored remotely via email.
- Scheduled UPS service mode and other systems status.
- Graphical user interface for Windows-compatible platforms.
- Automatic unattended local shutdown.
- Special modules for MS-Office software to close and save open documents.
- Compatible with all optional modules like UPSDIALER, SNMP adaptors, temperature sensors, etc.

### Functional description

WAVEMON is a client/server software application for networks and local workstations. In general, it consists of two parts: the server module of the UPS management software is *UPSMAN*, which communicates with the UPS via an RS232/USB interface. Running as a background application, *UPSMAN* collects and interprets the messages received from the UPS and places them at the disposal of the client module *UPSMON*, as well as any connected SNMP-based instrumentation and control system.

If *UPSMAN* detects voltage variations or a power failure, it can execute various 'system event' routines, by means of which, for example, the server is switched off or a warning/alarm is sent to the connected users. These 'system event' routines are a part of the management software and can be configured in to suit local application requirements.

The software of your PowerWAVE 6000 S3 UPS unit can be integrated into a network in two ways:

1. By the server which is supplied by the UPS itself and has been integrated into the network. In most cases this server is used as a sub-agent and you only need the WAVEMON software (without an SNMP adapter). You will also need to establish an RS232/USB connection between the UPS and computer/server.
2. In many cases the use of what is referred to as an 'SNMP adapter' is to be preferred in order to integrate the UPS into the network. In this case up to 50 computers can be shut down in one RCCMD environment. RCCMD (remote console command) is an additional software module that is used in order to execute a command (typically a shutdown command) in a remote system.

### Licensing

A licence is issued with every software serial number for use of what is known as the 'UPS service' on a single server in connection with one UPS and an unlimited number of connected WINDOWS workstations. For operation with two or more servers, a further licence is required for each additional server. In this case it is of no importance whether the UPS service on these servers is active or whether the server was stopped by a remote UPS service. The same applies to the use of RCCMD with the 'remote send/receive' modules for 'multi-server shutdown' under NT, UNIX and other operating systems.

The service programs are generally supplied as single licences. In order to use a single CD-ROM for several 'multi-server shut-down' units you must acquire additional licence codes.

### RCCMD Server shutdown

In order that remote shutdown of servers can take place, initiated by the SNMP card or WAVEMON software, further licenses must be purchased. The license is for the RCCMD client (or listening) software that resides in each target server.

## POWERREPORTER™ MANAGEMENT SOFTWARE

PowerREPORTER is a remote monitoring and management service which provides peace-of-mind protection by offering a continuous (24/7/365) watch over mission-critical facilities. Continuous monitoring is an affordable insurance policy to detect issues and provide an early warning before they develop into a crisis.

The main features and benefits offered by PowerREPORTER are:

- Real time email notification sent directly to UPSL Service Centre in response to alarm/critical events.
- Acquisition of key performance data and productivity information. Empowers you with the details needed to better understand machine performance and quickly troubleshoot downtime events.
- Combined with a service contract, PowerREPORTER improves service levels. The engineer can determine if site attendance is necessary and bring relevant spare parts.
- Monthly Status Report detailing trends and alarms.



- Optional battery analysis and care service; PowerNSURE - measures battery voltage, temperature, impedance and prolongs battery service life through the application of battery charge equalization.

### Functional description

PowerREPORTER communicates constantly with your UPS system in order to automatically detect any error or alarm messages. In the event of an incident being detected, PowerREPORTER automatically connects with UPS Limited Service Centre via an email, transmitting a status message.

The email, which provides details relating to the fault, a snapshot of the UPS performance parameters and a device identification string, is automatically processed and UPS Limited Service Centre personnel are alerted.

UPS Limited Service Centre personnel are then able to liaise with the company's field service team and will remotely diagnose the UPS incident before reaching the facility with appropriate spare parts within the contracted service agreement time-frame.

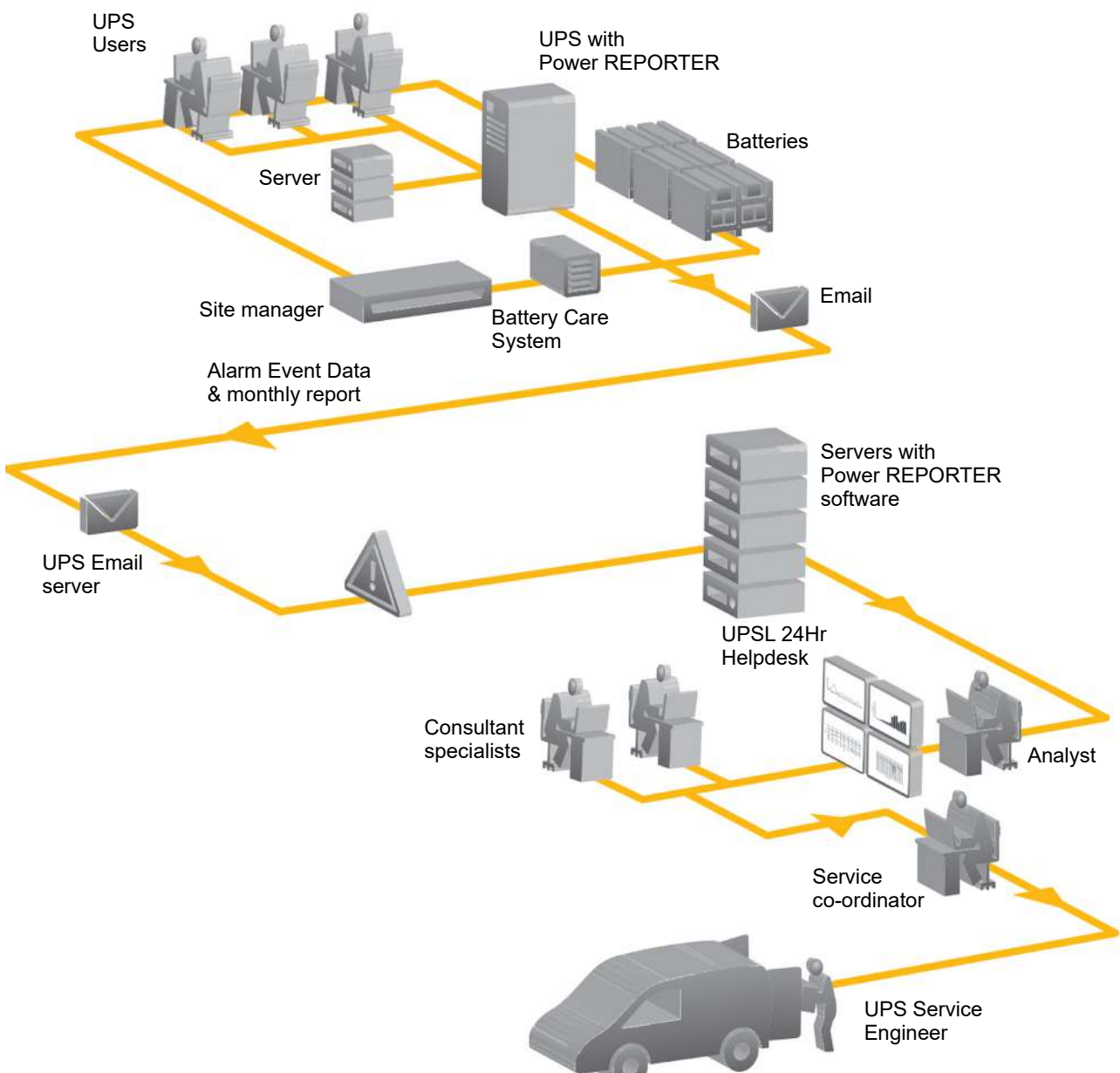

**Figure 1 PowerREPORTER operation**

## PLANNING THE INSTALLATION (SITE CONSIDERATIONS)

A certain amount of pre-planning will help ensure a smooth and trouble-free installation of the UPS system. The following guidelines should be taken into account when planning a suitable UPS location and operating environment.

1. The route to the installation location must allow the equipment to be transported in an upright position.
2. The floor at the proposed installation site and en-route from the off-loading point must be able to safely take the weight of the UPS and battery equipment plus the fork lift during transit.
3. Locations with high ambient temperature, moisture or humidity must be avoided.
  - a) The installation site humidity should be <95% non-condensing.
  - b) The prescribed ambient temperature is 0°C to +40°C. An temperature of 20°C is recommended to achieve a long battery life.
  - c) The prescribed cooling air flow must be available. The air entering the UPS must not exceed +40°C.
  - d) The air conditioning system must be able to provide a sufficient amount of cooling air to keep the room within the prescribed temperature range.
4. The following environmental conditions should also be considered:
  - a) Fire protection standards must be respected.
  - b) The location must be free of dust and corrosive or explosive gases.
  - c) The location must be vibration free.
  - d) If the UPS is located in bayed enclosures, partition walls must be installed.
  - e) The available space must permit the minimum cabinet clearances shown below.

### Clearances

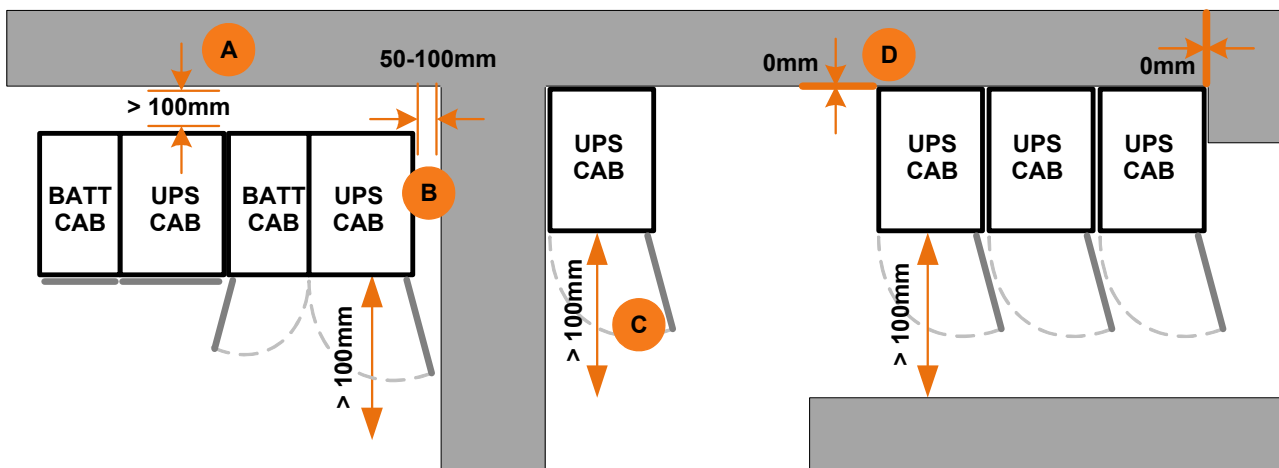

The above diagram illustrates the space requirements when installing a single or multi-module PowerWAVE 6000 S3 system, with or without an adjacent battery cabinet(s). All cables enter the UPS via the bottom of the cabinet and no side or rear access is required for service or installation. All cabinets are force-ventilated by top-mounted extraction fans which require a minimum of 400mm space at the top of the cabinet to allow adequate exhaust air flow.

A minimum of 1000mm clearance is required at the front of the cabinets for service access (C), and where possible this should be increased to allow safe passage in front of the UPS with the doors open.

The cabinet(s) do not require rear or side clearance (D). However, it is necessary to open the door by slightly more than 90° to gain access to some components, so if the cabinet is located adjacent to a partition or wall that extends beyond the front of the cabinet (B) a side clearance of 50-100mm (B) should be provided between the cabinet and the partition/wall to allow the doors to open adequately. Note that if this is not possible the doors have been designed to be easily removable to aid the required internal access.

If a battery cabinet forms part of the UPS suite it is normally situated immediately adjacent to the UPS cabinet and requires a minimum rear clearance of 100mm to allow adequate ventilation (A).

## PLANNING THE INSTALLATION (CABLING CONSIDERATIONS)

The UPS input and bypass terminals should be connected to the utility mains supply through a suitable LV-Distribution board containing a circuit breaker or fused isolator to provide suitable overload protection and a means of isolating the UPS from the mains supply when required. Similarly, the UPS output supply terminals should be connected to the load equipment via a suitably fused load distribution board.

### Input neutral grounding

A permanently connected input neutral is required to enable the rectifier to operate correctly and allow the UPS to function properly when operating on battery. The input neutral must also be grounded to permit correct operation when the UPS is running on battery.



**Key Point:** As the input neutral must be unswitched and connected to the UPS at all times, a 4-pole input switch or isolator must not be used at the LV Distribution board on a TN-S system.

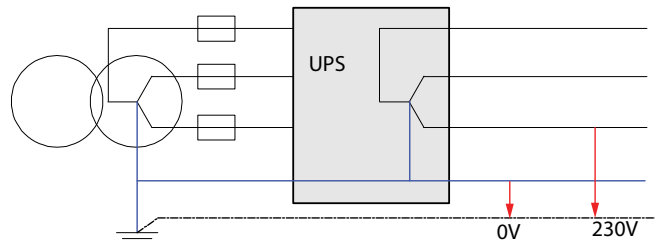

### Cable and fuse sizing

#### Single feed / Dual feed inputs

The UPS can be wired for a 'single feed' input (standard), whereby the UPS input mains terminals and bypass mains terminals are internally linked; or it can be wired for a 'dual feed' input, where the UPS bypass mains terminals are connected to a dedicated bypass supply.

Both configurations are shown on pages 17 (single feed) and 18 (dual feed) together with details of the recommended fuse and cable ratings.



**Key Point:** The information on pages 17 and 18 is provided for guidance only:

- Fuse and cable recommendations are to IEC 60950-1:2001.
- All external fuses, isolators and power cables must be rated and installed in accordance with the prescribed IEC standards or local regulation – e.g. BS7671.
- External DC Cables and battery fuses are bespoke to the installation.

### Battery fuses and cables

Battery fuses and cables are bespoke to the installation. The following table is given for *guidance* only.

Power (kVA)	Fuse E (gl/CB)	Cable E (Qty x mm <sup>2</sup> )
60	2x 160A	2x (1x 50)
80	2x 200A	2x (1x 95) for 42-45 battery blocks 2x (1x 70) for 46-50 battery blocks
100	2x 250A	2x (1x 120) or 2x (2x 50) for 42-45 battery blocks 2x (1x 95) for 46-50 battery blocks
120	2x 300A	2x (1x 150) or 2x (2x 50) for 42-45 battery blocks 2x (1x 120) or 2x (2x 50) for 46-50 battery blocks

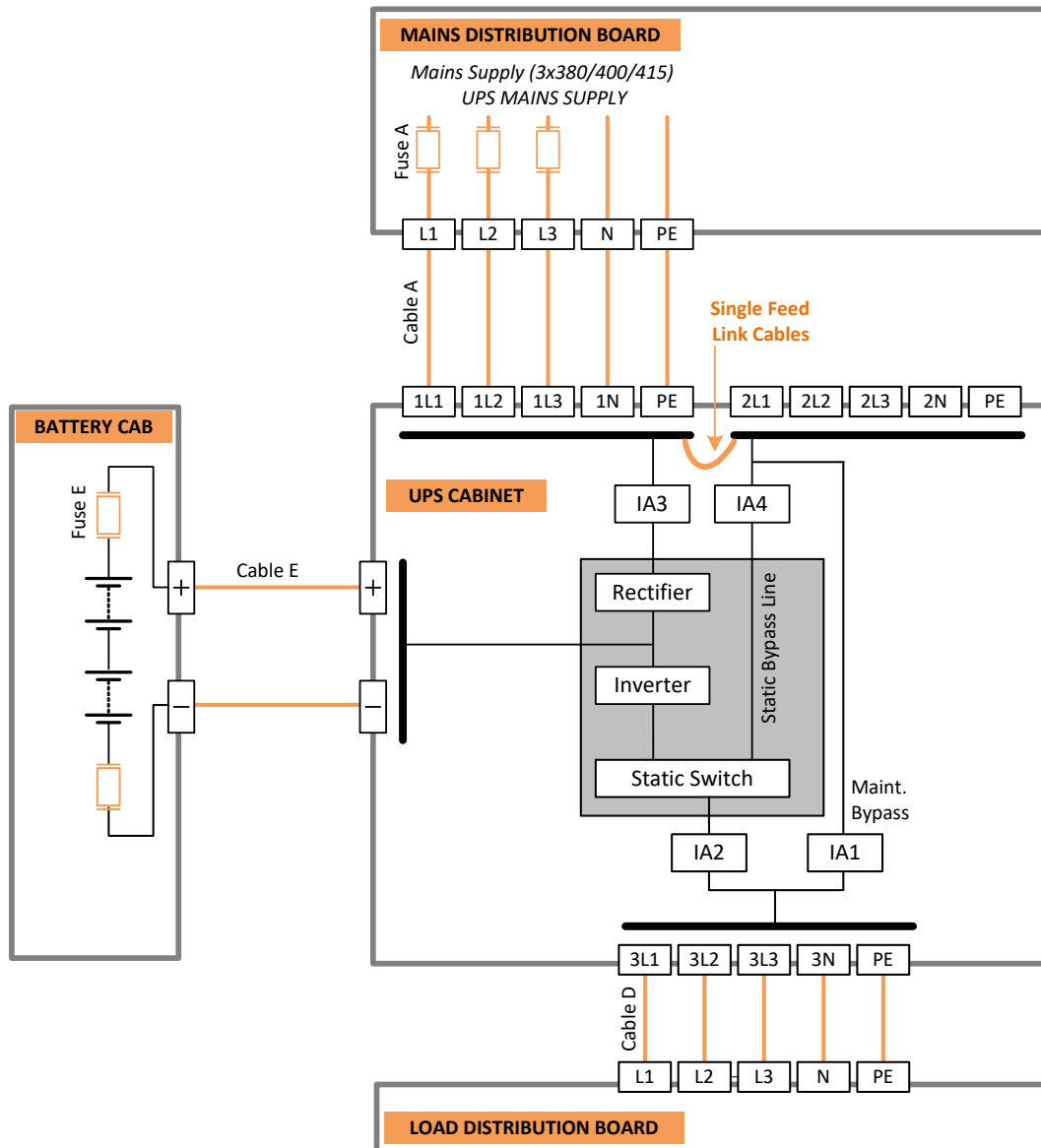

Power (kVA)	Fuse A (gl/CB)	Cable A (Qty x mm <sup>2</sup> )	Cable D (Qty x mm <sup>2</sup> )
60	3x100	5x35	5x35
80	3x125	5x50	5x50
100	3x160	5x50	5x50
120	3x200	5x70	5x70

**IMPORTANT NOTE:** The UPS does not contain internal fuses to protect the bypass and rectifier mains inputs. It is the customer's responsibility to ensure the UPS external supply fuses (or other devices) are correctly sized to provide the recommended level of UPS protection. We also recommend that a spare set of fuses are held locally to ensure they are easily available if required.

**Figure 2 Single feed input fuse and cable ratings**

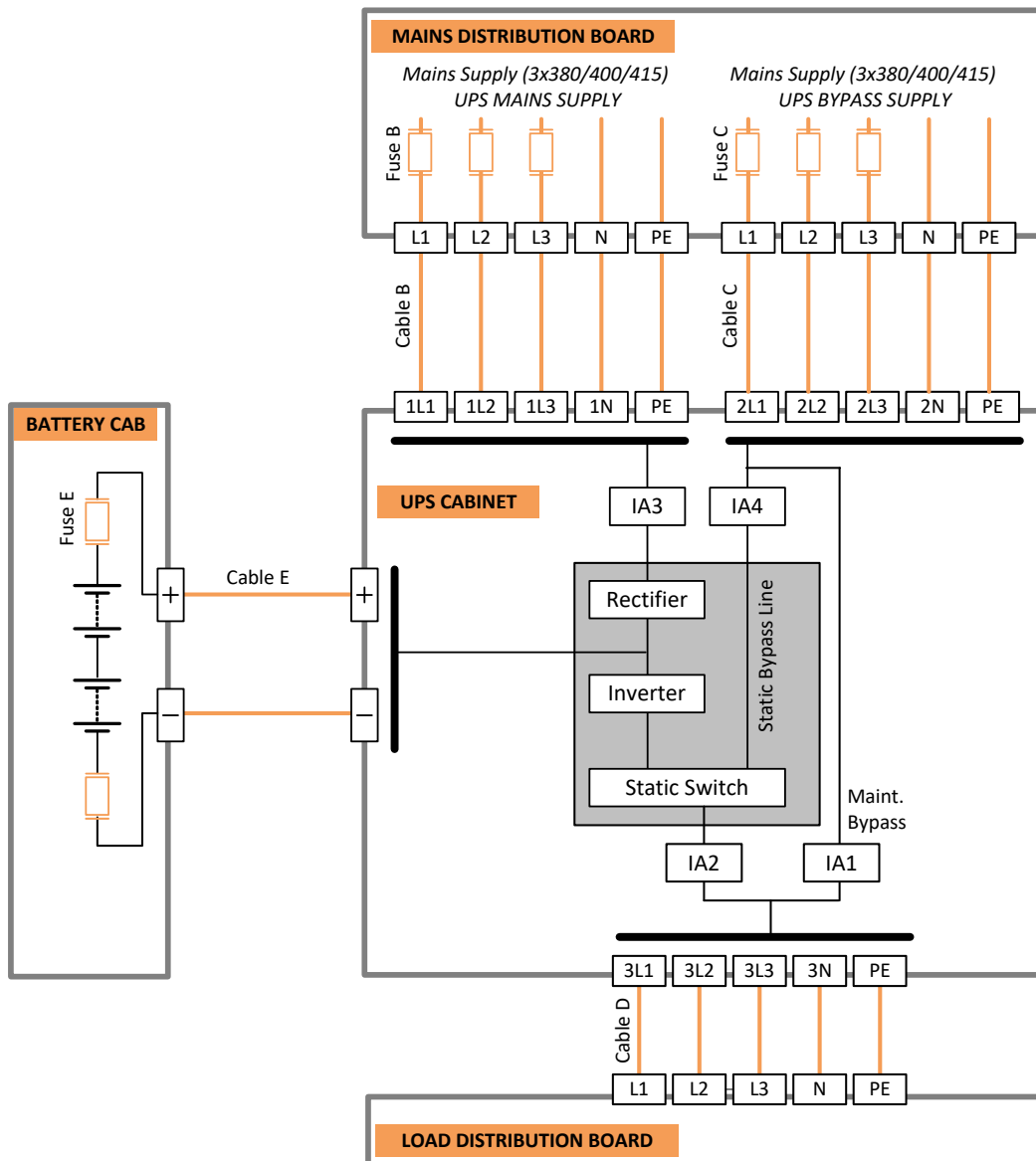

Power (kVA)	Fuse B (gl/CB)	Cable B (Qty x mm <sup>2</sup> )	Fuse C (gl/CB)	Cable C (Qty x mm <sup>2</sup> )	Cable D (Qty x mm <sup>2</sup> )
60	3x100	5x35	3x100	5x35	5x35
80	3x125	5x50	3x125	5x50	5x50
100	3x160	5x50	3x160	5x50	5x50
120	3x200	5x70	3x200	5x70	5x70

**IMPORTANT NOTE:** The UPS does not contain internal fuses to protect the bypass and rectifier mains inputs. It is the customer's responsibility to ensure the UPS external supply fuses (or other devices) are correctly sized to provide the recommended level of UPS protection. We also recommend that a spare set of fuses are held locally to ensure they are easily available if required.

**Figure 3 Dual feed input fuse and cable ratings**

### Power cable termination details

All the UPS input/output power cables are bolted to busbar terminals as illustrated below. The table below details the maximum size of the cable terminations and the correct torque that should be applied to the termination bolts.

	Mains Input (3+N+PE)	Bypass Input (3+N)	UPS Output (3+N+PE)	Battery, Neutral, PE	Tightening Torque (Nm)
60kVA	2x M8	1x M8	2x M8 1x M10	5x M8	12.3 (M8) 25.1 (M10)
80kVA	2x M8	1x M8	2x M8 1x M10	5x M8	12.3 (M8) 25.1 (M10)
100kVA	2x M8	1x M8	2x M8 1x M10	5x M8	12.3 (M8) 25.1 (M10)
120kVA	2x M8	1x M8	2x M8 1x M10	5x M8	12.3 (M8) 25.1 (M10)

### UPS Power terminals

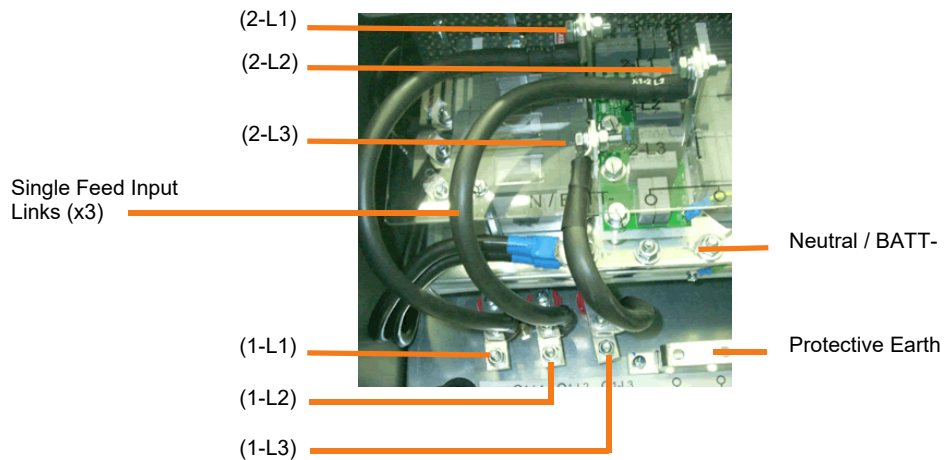
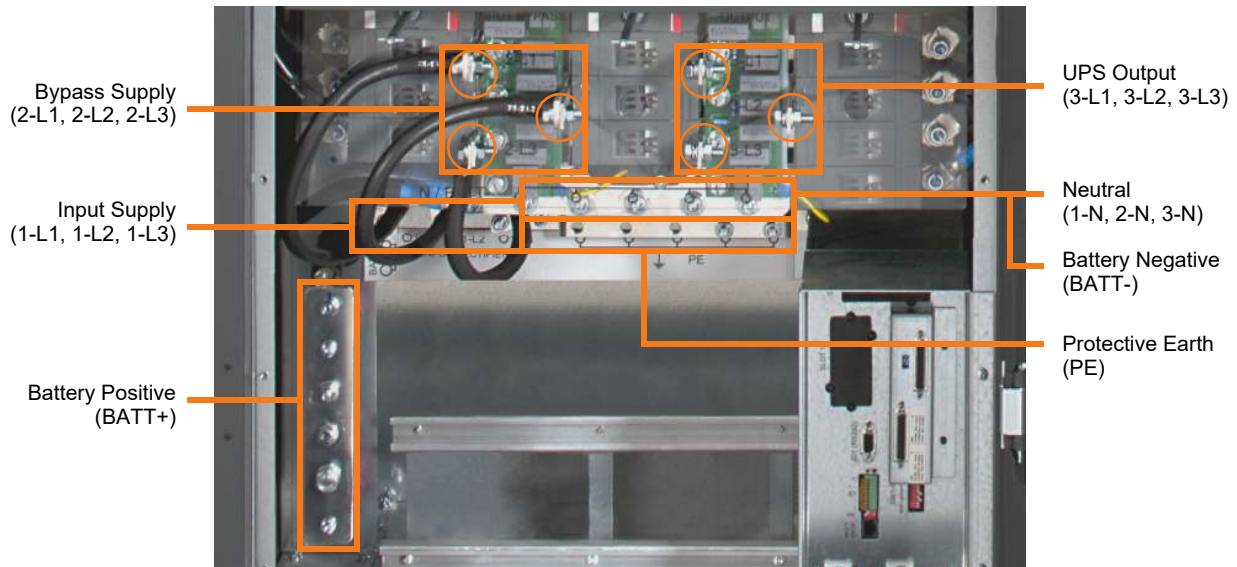

### Power cabling in a parallel system

In order to achieve equal load sharing between the various UPS cabinets in a multi-cabinet installation, the input cables from the mains distribution board to each UPS cabinet should be of equal length. Similarly the UPS output cables to the load distribution board should be of equal length.

**CORRECT**

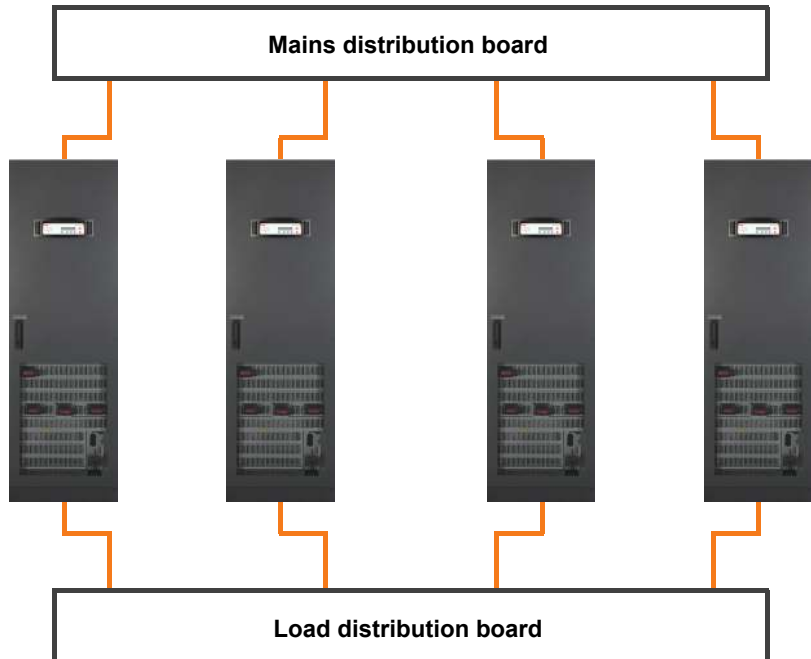

**INCORRECT**

