

PowerWAVE 5000/TP (10–50 kVA)

Technical Specification

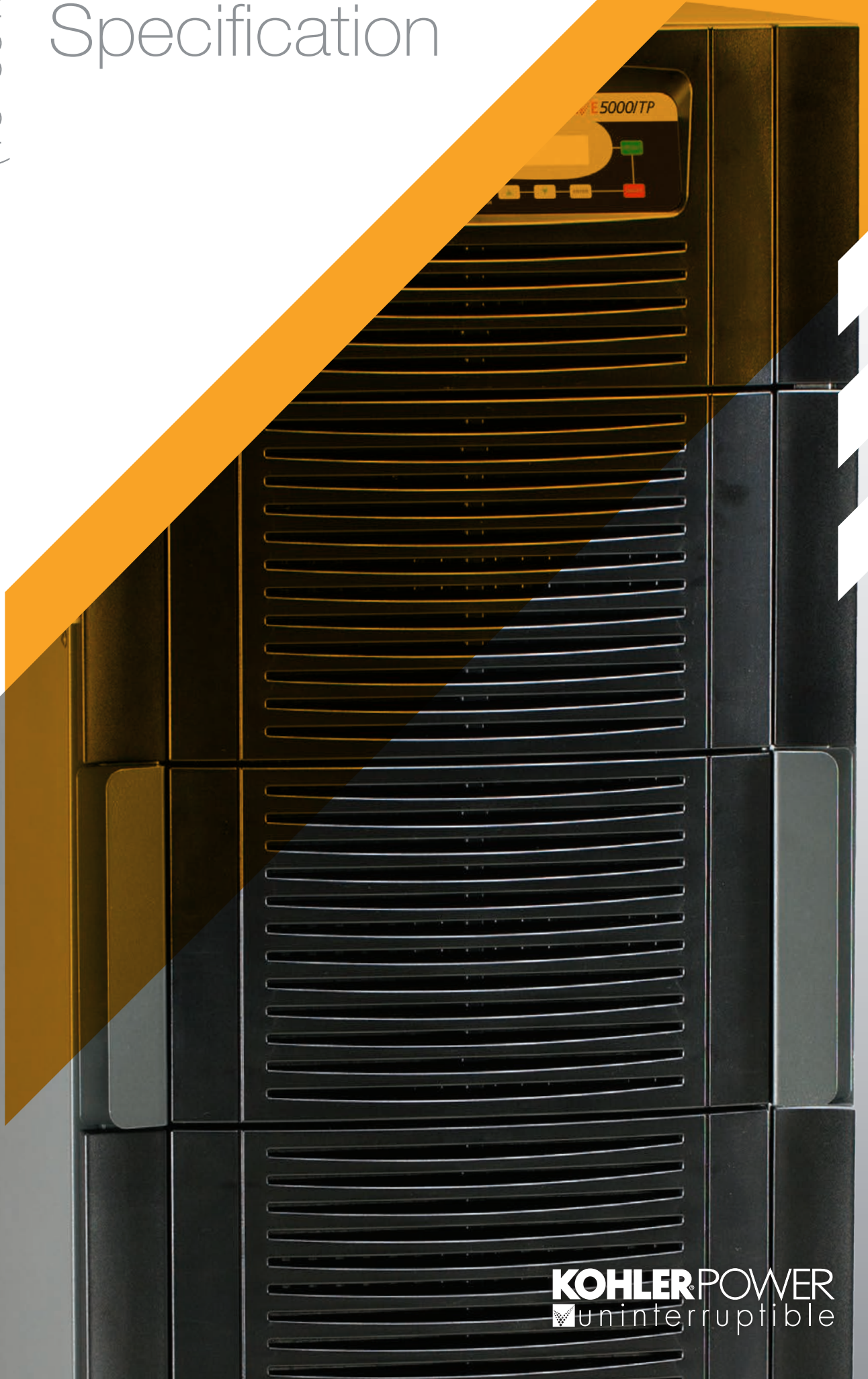

POWERWAVE 5000/TP SYSTEM DESCRIPTION

The availability of protected and continuous power is essential in today's dynamic IT and process-related environments, where demands can change rapidly through the introduction of new server technologies, migration and centralisation. In environments such as these, not only must the power protecting equipment be reliable but it must also be resilient and easily adaptable to suit changing load requirements – attributes that are readily apparent in the PowerWAVE 5000/TP series Uninterruptible Power Supply (UPS).

The PowerWAVE 5000/TP represents a completely new generation of mid-range, 3 phase UPS systems, incorporating the latest technological developments in power engineering. Its advanced double conversion, Voltage and Frequency Independent (VFI), topology fully satisfies the highest availability and environmentally-friendly requirements compliant with IEC 62040-3 (VFI-SS-111) standards. High reliability, upgrade ability, low operating costs and excellent electrical performance are just some of the highlights of this innovative UPS solution.

The PowerWAVE 5000/TP is designed to respond to the most stringent safety, EMC and other important UPS standards.

PowerWAVE 5000/TP is a stand-alone UPS module available in seven power ranges: 10, 15, 20, 25, 30, 40 & 50 kVA.

Each PowerWAVE 5000/TP module can operate as a stand-alone UPS, or up to 20 units can be connected in parallel to operate as a multi-module UPS system. A parallel system configuration is generally chosen either to increase the system's total output power capacity, or to provide module redundancy to enhance the overall system reliability.

When operating in a parallel system, each UPS module can assume the paralleling control 'leadership' role which avoids a single point of failure in the parallel chain and ensures the highest level of reliability.

Note: Although the UPS single/multi configuration can be modified in the field it is generally specified on ordering so that the module can be configured and fully tested in the factory prior to despatch.

The most demanding IT infrastructures begin with low power requirements which gradually increases as it builds up to full capacity. To avoid putting the load at risk, it is essential to be able to increase the amount of available power as the infrastructure grows. The modular design of the PowerWAVE 5000/TP system allows the parallel configuration to be expanded to cater for increasing load demands without interrupting the load or temporarily transferring it to an unprotected bypass supply.

This Technical Specification provides detailed technical information on the mechanical, electrical and environmental performance of the PowerWAVE 5000/TP that can support and give answers to tender and end user requirements.

| KEY FEATURES | |
|--|--|
| Best-in-class efficiency | Energy-Operational cost savings (TCO) |
| Compact size, small foot print | Expensive floor space savings |
| Blade-server-friendly power; full power from 0.9 lead to 0.73 lag | No de-rating required with leading PF loads |
| Very low input current harmonic distortion THDi = 3% @100% load | Gen-set power and installation cost savings |
| Input Power Factor near unity | Cost savings during installation and the entire life cycle (TCO) |

GENERAL SPECIFICATIONS

| MECHANICAL CHARACTERISTICS | | Module Rating (kVA) | | | | | | |
|--|----|---------------------|-----|-----|------------------|-----|-----|-----|
| | | 10 | 15 | 20 | 25 | 30 | 40 | 50 |
| UPS CABINET A (without battery enclosure) | | | | | | | | |
| Dimensions (WxHxD) | mm | 345 x 720 x 710 | | | | | | |
| Weight without battery | kg | 60 | 62 | 64 | | | | |
| Weight with 48x7/9Ah battery | kg | 180 | 182 | 184 | | | | |
| Weight with standard packaging | kg | +4 | | | | | | |
| Colour | | Black (RAL 9005) | | | | | | |
| UPS CABINET B (without battery enclosure) | | | | | | | | |
| Dimensions (WxHxD) | mm | 345 x 1045 x 710 | | | | | | |
| Weight without battery | kg | 88 | 90 | 92 | 94 | | | |
| Weight with 96x7/9Ah battery | kg | 328 | 330 | 332 | 334 | | | |
| Weight with standard packaging | kg | +5 | | | | | | |
| Colour | | Black (RAL 9005) | | | | | | |
| UPS CABINET C (without battery enclosure) | | | | | | | | |
| Dimensions (WxHxD) | mm | | | | 440 x 1420 x 910 | | | |
| Weight (7/9Ah cab without battery) | kg | | | | 151 | 160 | 165 | 170 |
| Weight (28Ah cab without battery) | kg | | | | 135 | 145 | 150 | 155 |
| Weight with 144x7/9Ah battery | kg | | | | 540 | 550 | 555 | 560 |
| Weight with 48x28Ah battery | kg | | | | 605 | 615 | 620 | 625 |
| Weight with standard packaging | kg | | | | +5 | | | |
| Colour | | | | | Black (RAL 9005) | | | |

| INPUT CHARACTERISTICS | | Module Rating (kVA) | | | | | | |
|--|----|---|------|------|------|------|------|------|
| | | 10 | 15 | 20 | 25 | 30 | 40 | 50 |
| Input Voltage | V | 3x380/220V+N, 3x400V/230V+N, 3x415/240V+N | | | | | | |
| Input Voltage Tolerance (ref to 3x400/230V) for Loads in %: | V | (-23%/+15%) 3x308/177 V to 3x460/264 V for <100% load (-30%/+15%) 3x280/161 V to 3x460/264 V for < 80% load (-40%/+15%) 3x240/138 V to 3x460/264 V for < 60% load | | | | | | |
| Input Frequency | Hz | 35 - 70 | | | | | | |
| Input Power Factor | | PF=0.99 @ 100% load | | | | | | |
| Inrush Current | A | max. In | | | | | | |
| Input Distortion THDi | | Sine-wave THDi = 3.0% @ 100% load | | | | | | |
| Max. Input Power with rated output power and charged battery (output pf = 0.9) | kW | 9.6 | 14.4 | 19.1 | 23.9 | 28.7 | 38.3 | 47.9 |
| Max. Input Current with rated output power and charged battery (output pf = 0.9) | A | 13.9 | 20.8 | 27.8 | 34.7 | 41.6 | 55.5 | 69.4 |

| | | | | | | | | |
|---|----|------|------|------|------|------|------|------|
| Max. Input Power with rated output power and discharged battery (output pf = 0.9) | kW | 10.5 | 15.7 | 21 | 26.2 | 31.4 | 41.9 | 52.4 |
| Max. Input Current with rated output power and discharged battery (output pf = 0.9) | A | 15.2 | 22.8 | 30.4 | 37.9 | 45.5 | 60.7 | 75.9 |

| OUTPUT CHARACTERISTICS | | Module Rating (kVA) | | | | | | |
|--|-----|--|------|------|------|------|------|------|
| | | 10 | 15 | 20 | 25 | 30 | 40 | 50 |
| Output Rated Power | kVA | 10 | 15 | 20 | 25 | 30 | 40 | 50 |
| Output Current @ rated kVA (400 V) | A | 14.4 | 21.7 | 28.9 | 36.1 | 43.3 | 57.7 | 72.2 |
| Output Rated Power | KW | 9 | 13.5 | 18 | 22.5 | 27 | 36 | 45 |
| Output Current @ rated kW (400 V) | A | 13.0 | 19.5 | 26.0 | 32.5 | 39.0 | 52.0 | 65.0 |
| Output Rated Voltage | V | 3x380/220V or 3x400/230V or 3x415/240V | | | | | | |
| Output Voltage Stability | % | Static: < ±1% Dynamic (Step load 0%-100% or 100%-0%) < ±4% | | | | | | |
| Output Voltage Distortion | % | With Linear Load < 2% With Non-linear Load (EN62040-3:2001) < 4% | | | | | | |
| Output Frequency | Hz | 50 Hz or 60 Hz | | | | | | |
| Output Frequency Tolerance | Deg | Synchronized with mains < ±2% (selectable for bypass operation) or < ±4% Free running ±0.1% | | | | | | |
| Bypass operation | | At input voltage of 3x400 V ±15%, or 196 V to 264 V ph-N | | | | | | |
| Permissible Unbalanced Load (All 3 phases regulated independently) | % | 100% | | | | | | |
| Phase Angle Tolerance (With 100% Unbalanced load) | Deg | ±0 deg. | | | | | | |
| Overload Capability on Inverter @ 0.8 p.f. | % | 125% load 10 min. 150% load 1 min. | | | | | | |
| Overload Capability on Inverter @ 0.9 p.f. | % | 110% load 10 min. 130% load 1 min. | | | | | | |
| Output short capability (RMS) | A | Inverter: up to 3 x I _n during 40 ms Bypass: 10 x I _n during 10 ms | | | | | | |
| Crest - Factor | | 3: 1 | | | | | | |

| HEAT DISSIPATION (Non-linear Loads) | | Module Rating (kVA) | | | | | | |
|--|-------|---------------------|------|------|------|------|------|------|
| | | 10 | 15 | 20 | 25 | 30 | 40 | 50 |
| Heat Dissipation with 100% Non-linear Load per range (EN 62040-3) | W | 600 | 900 | 1100 | 1400 | 1700 | 2300 | 2900 |
| Heat Dissipation with 100% Non-linear Load per range (EN 62040-3) | BTU/h | 2048 | 3072 | 3754 | 4778 | 5802 | 7850 | 9898 |
| Airflow (25°C - 30°C) with 100% Non-linear Load per range (EN 62040-3) | m³/h | 150 | 150 | 150 | 150 | 570 | 570 | 570 |
| Heat Dissipation without load | W | 120 | 150 | 150 | 170 | 250 | 300 | 350 |

| BATTERY CHARACTERISTICS | Module Rating (kVA) | | | | | | | | | | | | |
|--|---|---|--------|---|--------|---|--------|----|--------|---|--------|---|--------|
| | 10 | | 15 | | 20 | | 25 | | 30 | | 40 | | 50 |
| Cabinet Type | A | B | A | B | A | B | B | C | C | C | C | C | |
| Maximum Battery Charger Current | 4A | | | | | | | 6A | | | | | |
| Battery Charging Curve | Ripple free; IU (DIN 41773) | | | | | | | | | | | | |
| Temperature compensation ready | Standard (temp. sensor optional) | | | | | | | | | | | | |
| Battery Test | Automatic and periodically (adjustable) | | | | | | | | | | | | |
| Battery Type | Maintenance free VRLA or NiCd | | | | | | | | | | | | |
| Min/Max Number of 12V Battery Blocks per string | 22-50* | | 32-50* | | 32-50* | | 40-50* | | 24-50* | | 32-50* | | 40-50* |
| * Depending on the effective load in kW used by the system (numbers shown are for 0.8 - 0.9 pf only) | | | | | | | | | | | | | |

| Description | 10kVA | | | | | | 15kVA | | | | | | | | | |
|---|----------|----------|----------|----------|----------|----------|----------|----------|----------|----------|----------|----------|----------|----------|----------|----------|
| | A | | | B | | | A | | | B | | | | | | |
| Maximum Power [kW] | 6 | 8 | 9 | 6 | 8 | 9 | 8 | 10 | 12 | 13.5 | 8 | 10 | 12 | 13.5 | | |
| Minimum number of battery blocks per string | 20 | 24 | 26 | 20 | 24 | 26 | 24 | 28 | 32 | 36 | 24 | 28 | 32 | 36 | | |
| Maximum No. 7/9Ah battery blocks in cabinet | 48 | 48 | 48 | 2x4 8 | 2x4 8 | 2x4 8 | 48 | 48 | 48 | 48 | 2x4 8 | 2x4 8 | 2x4 8 | 2x4 8 | | |
| Description | 20kVA | | | | | | 25kVA | | | | | | | | | |
| Cabinet Type | A | | | B | | | B | | | C | | | | | | |
| Maximum Power [kW] | 9 | 12 | 16 | 18 | 9 | 12 | 16 | 18 | 12 | 16 | 20 | 22.5 | 12 | 16 | 20 | 22.5 |
| Minimum number of battery blocks per string | 26 | 32 | 40 | 44 | 26 | 32 | 40 | 44 | 32 | 40 | 46 | 48 | 24 | 32 | 40 | 46 |
| Maximum No. 7/9Ah battery blocks in cabinet | 48 | 48 | 48 | 48 | 2x4 8 | 2x4 8 | 2x4 8 | 2x4 8 | 2x4 8 | 2x4 8 | 2x4 8 | 2x4 8 | 3x4 8 | 3x4 8 | 3x4 8 | 3x4 8 |
| Maximum No. 28Ah battery blocks in cabinet | N/A | | | N/A | | | N/A | | | N/A | | | 1x4 8 | 1x4 8 | 1x4 8 | 1x4 8 |
| Description | 30kVA | | | | 40kVA | | | | 50kVA | | | | | | | |
| Cabinet Type | C | | | | C | | | | C | | | | | | | |
| Maximum Power [kW] | 16 | 20 | 24 | 27 | 18 | 25 | 32 | 36 | 30 | 35 | 40 | 45 | | | | |
| Minimum number of battery blocks per string | 16 | 20 | 24 | 28 | 18 | 26 | 32 | 36 | 30 | 34 | 40 | 46 | | | | |
| Maximum No. 7/9Ah battery blocks in cabinet | 3x4 8 | 3x4 8 | 3x4 8 | 3x4 8 | 3x4 8 | 3x4 8 | 3x4 8 | 3x4 8 | 3x4 8 | 3x4 8 | 3x4 8 | 3x4 8 | | | | |
| Maximum No. 28Ah battery blocks in cabinet | 1x4 8 | 1x4 8 | 1x4 8 | 1x4 8 | 1x4 8 | 1x4 8 | 1x4 8 | 1x4 8 | 1x4 8 | 1x4 8 | 1x4 8 | 1x4 8 | | | | |

| COMMUNICATION OPTIONS | Module Rating (kVA) | | | | | | |
|--|--|----|----|----|----|----|----|
| | 10 | 15 | 20 | 25 | 30 | 40 | 50 |
| STANDARD ITEMS | | | | | | | |
| Power Management Display (PMD) | LCD display and mimic diagram showing UPS operational status | | | | | | |
| JD1 – RS232 on Sub-D9 port | For monitoring and integration in network management | | | | | | |
| X1 – Customer Interfaces: Inputs (DRY PORTS) | <ul style="list-style-type: none"> • 1 Remote Shut down [EMERGENCY OFF (Normally closed)] • 1 GEN-ON (Normally open) • 1 Programmable Customer's Inputs (Normally open) • 1 Battery Temperature Sensor for enhanced battery charging control • 1 12Vdc source (max. 250mA) to supply remote monitor | | | | | | |
| JR1 – RJ45 port | For multidrop purpose (optional) | | | | | | |
| OPTIONAL ITEMS | | | | | | | |
| Relay card +USB Including: X2 – Customer Interfaces: Outputs (DRY PORTS) | <ul style="list-style-type: none"> • Common Alarm • Load on Bypass • Battery Low • Load on Inverter • Mains Failure | | | | | | |
| RS232 on USB Port | For remote signalling and automatic computer shutdown | | | | | | |
| SNMP Card (slot already included) | For monitoring and integration into network management | | | | | | |

| ENVIRONMENTAL | Module Rating (kVA) | | | | | | | |
|---|---------------------------------|---|-------|-------|----------------------------|-------|-------|-------|
| | 10 | 15 | 20 | 25 | 30 | 40 | 50 | |
| Audible Noise with 100% / 50% Load | dBA | 55/49 | 55/49 | 57/49 | 57/49 | 58/50 | 59/50 | 59/50 |
| Operating temperature | °C | 0 - 40 | | | | | | |
| Battery temperature | °C | 20 | | | | | | |
| Battery Storage Time | | Max. 6 months | | | | | | |
| Max. altitude (above sea level) | m | 1000m (3300ft) without de-rating | | | | | | |
| De-rating factor for use at altitudes above 1000m sea level according (IEC 62040-3) | ALL MODULES | | | | | | | |
| | Metres above sea level (m / ft) | | | | De-Rating Factor for Power | | | |
| | 1500 / 4850 | | | | 0.95 | | | |
| | 2000 / 6600 | | | | 0.91 | | | |
| | 2500 / 8250 | | | | 0.86 | | | |
| 3000 / 9900 | | | | 0.82 | | | | |
| Relative Air-humidity | | Max. 95% (non-condensing) | | | | | | |
| Positional Clearances | | Front: A minimum of 900mm should be allowed for free passage. Side: 600mm left and right side access is required for service. Rear: A minimum of 200mm is required for cooling air circulation and the unit should be cabled such that it can be pulled forward to allow 600mm rear clearance for service/maintenance. | | | | | | |
| Accessibility (Operator) | | 10kVA – 25kVA in type A or B cabinets require front/rear access 25kVA – 50kVA in type C cabinets require front access only | | | | | | |

| ENVIRONMENTAL | Module Rating (kVA) | | | | | | |
|--|--|-------|-------|-----|-------|----|----|
| | 10 | 15 | 20 | 25 | 30 | 40 | 50 |
| Input and Output Power Cabling | 10kVA – 25kVA in type A or B cabinets are cabled at the rear 25kVA – 50kVA in type C cabinets are cabled at the front | | | | | | |
| Efficiency AC-AC up to (at pf=1.0) (depending on UPS power) | Load: | 100% | 75% | 50% | 25% | | |
| | Efficiency: | 95.5% | 95.5% | 95% | 94.5% | | |
| ECO Mode efficiency at 100% load | % | 98% | | | | | |

| STANDARDS | Module Rating (kVA) | | | | | | |
|--|---|----|----|----|----|----|----|
| | 10 | 15 | 20 | 25 | 30 | 40 | 50 |
| Safety | IEC/EN 62040-1-1:2003, IEC/EN 60950-1:2001/A11:2004 | | | | | | |
| Electromagnetic Compatibility | IEC/EN 62040-2:2005, IEC/EN61000-3-2:2000, IEC/EN61000-6-2:2001, | | | | | | |
| EMC Classes C2 domestic or industrial In < 16A C3 industrial In >16A | C2 | | | | | | C3 |
| Performance | IEC/EN62040-3:2001 | | | | | | |
| Product certification | CE | | | | | | |
| Degree of protection | IP 20 | | | | | | |

COMMUNICATION OPTION DETAILS

Power management display (PMD)

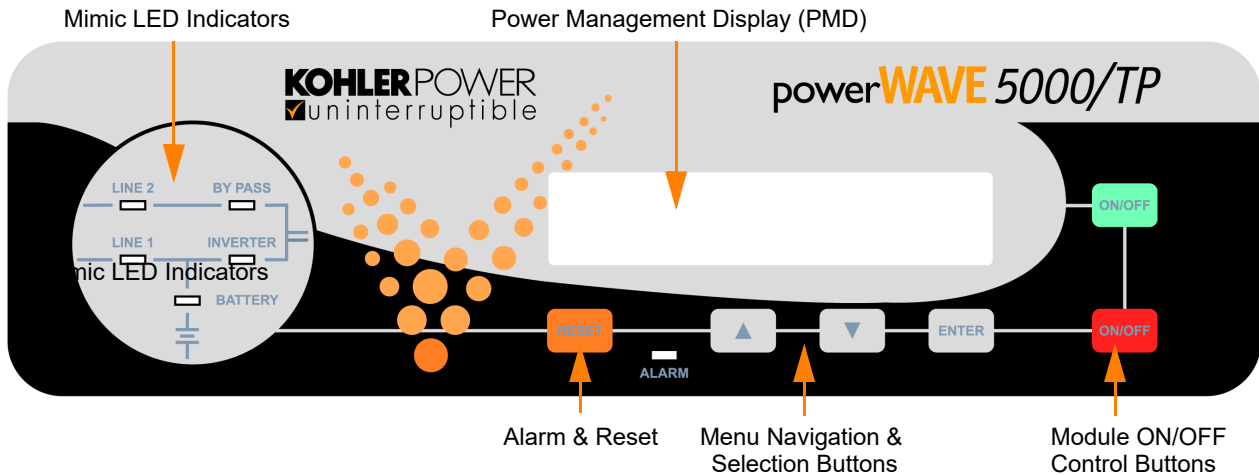

The user-friendly Power Management Display provides access to all monitoring information and operator controls.

Mimic Diagram

The mimic diagram contains multi-coloured LEDs that change between Green, Red and Off to indicate the UPS operation and power flow status.

LEDs LINE 1 and LINE 2 indicate the availability of the input mains and bypass mains power supplies respectively, and are both Green during normal operation.

The INVERTER and BYPASS LEDs indicate which of the two power sources is providing the critical load supply. These LEDs illuminate Green to indicate which is the active supply source.

The BATTERY LED indicator is a solid Green when the battery is being charged and flashes when the battery is discharging –e.g. when it is providing the load power following a mains failure.

The ALARM LED, located at the lower-centre area of the PMD, is a visual indication of any monitored internal or external alarm condition. When activated, it is accompanied by an audible alarm that can be cancelled by pressing the RESET button.

LCD Display Panel

The 2 x 20 character multi-function LCD Display is menu-driven using the UP, DOWN and ENTER keys. It provides a simple communications interface that enables the operator to monitor important UPS operating parameters and alarm warnings, and effect various control operations such as transferring the load between the inverter and bypass.

LCD Display Panel summary:

- Displays the input and output voltage, current, frequency and power
- Displays an 'Event register' which stores a date/time stamped history of the 99 most recent alarms
- Enables battery run time monitoring
- Enables selection of commands such as UPS Start-up and Shut-down, Load transfer from inverter to bypass and vice-versa
- Provides diagnostic facilities (service mode only)
- In conjunction with the operator keys, provides UPS adjustments and testing facilities (service mode only)

JD1 Smart Port – Serial RS 232 and USB Port

JD1 is a standard D-Type, 9-pin, female socket, and the USB is a standard USB port.

The SMART PORT is an intelligent RS 232 serial port that allows the UPS to be connected to a computer. When used in conjunction with the optional SMART PORT software, WAVEMON, it enables the computer to continuously monitor the mains voltage and UPS-status, and display a message in the event of any UPS system changes.

X1 Dry Port (volt-free contacts)

All the input and output interface connections to X1 are made to Phoenix terminals (cable 0.5mm²)

Connection of Remote Shut down facilities, Generator Operation, Customers specials.

| Terminal | Contact | Signal | Function |
|----------|---------|---------|--|
| X1/1 | In | +12Vdc | GENERATOR OPERATION |
| X1/2 | Gnd | Gnd | (NC = Generator ON) |
| X1/3 | In | +12Vdc | Customer IN 1 |
| X1/4 | Gnd | Gnd | (Function on request, to be defined) |
| X1/5 | In | +3.3Vdc | BATTERY TEMPERATURE |
| X1/6 | Gnd | Gnd | If connected, the battery charger current is temperature dependent |
| X1/7 | In | +12Vdc | REMOTE SHUTDOWN |
| X1/8 | Gnd | Gnd | Do not remove the factory mounted bridge until an external remote shut down is connected |
| X1/9 | In | +12Vdc | 12Vdc SOURCE |
| X1/10 | Gnd | Gnd | Max 200mA load (e.g. used to power remote indicator panels) |











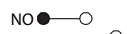
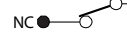

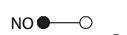
JR1 – RS485 Interface for multidrop

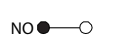
The Computer Interface JR1 is an intelligent RS485 serial port that allows system information to be gained from all modules that are connected in parallel using the Multidrop connection kit. The connector JR1 is a standard RJ45 socket.

X2 Dry Port – Optional output interfaces terminal block (X2)

All the input and output interface connections to X2 are made to Phoenix terminals (cable 0.5mm²)

X2 provides status and alarm signal outputs that can be used to initiate orderly shutdown of servers, AS400 or automated building management systems. All signals are provided via voltage free contacts are rated 60 VAC / 500 mA maximum.

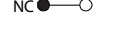
| Pin | Contact | Signal | Function | | |
|-----|---|---------|---------------|---|----------------------|
| 1 |  | Alarm | MAINS_OK | Mains Present | |
| 2 | | | |  | Mains Not Present |
| 3 | | | |  | Common |
| 4 |  | Message | LOAD_ON_INV | Load On Inverter | |
| 5 | | | |  | Load Not On Inverter |
| 6 | | | |  | Common |
| 7 |  | Alarm | BATT_LOW | Battery Low | |
| 8 | | | |  | Battery OK |
| 9 | | | |  | Common |
| 10 |  | Message | LOAD_ON_MAINS | Load On Mains | |
| 11 | | | |  | Load Not On Mains |
| 12 | | | |  | Common |
| 13 |  | Alarm | COMMON_ALARM | Common Alarm | |
| 14 | | | |  | No Alarm Condition |
| 15 | | | |  | Common |

Modem/Ethernet card / PowerREPORTER™ management software

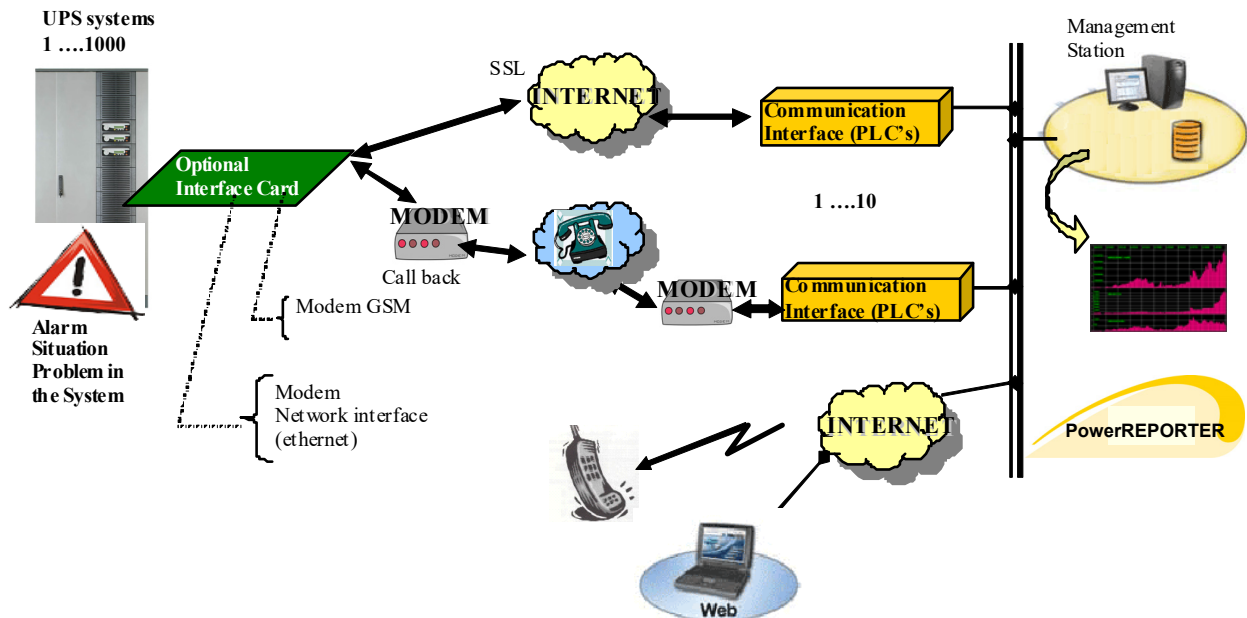

PowerREPORTER™ is a remote monitoring and management service which is a part of the premium power protection concept. Two solution cards are available to enable connection between the UPS and the outside world: 'Modem/Ethernet' or 'Modem/GSM'.

PowerREPORTER™:

- Provides affordable, continuous monitoring over mission-critical facilities and offers peace-of-mind by detecting and warning of any potential system problems before they become a crisis:
- Acquires key performance parameters and productivity information in real-time to enable you to better understand machine performance and faster troubleshoot downtime events.
- Gives total transparent information concerning all actions performed on the system, such as all critical status changes, coordination of equipment service, reporting of all alarms with priorities.

Key Features

- Redundant and secure communication
- Alarm acknowledgment
- Priority driven Management (with escalation)

Comprehensive Management System

- Reception and management of alarm calls from UPS
- Storage of UPS Data in a database exportable in a CSV-format for easy handling in Excel
- Unlimited number of UPS that can be managed
- User administration with passwords and permission-level
- Administration of Log file
- Data logging with statistical analysis and diagnostics, report
- Visualization of the UPS data
 - Current status ("single" and "parallel" operation)
 - Measured values for single or three phase
 - Recording function including graphs with zooming capabilities for selected measured values
 - Display of event log file
 - Display of UPS Parameters
 - Web Server functionality, for data access from any Web Browser

SNMP card/adaptor for network management/remote monitoring

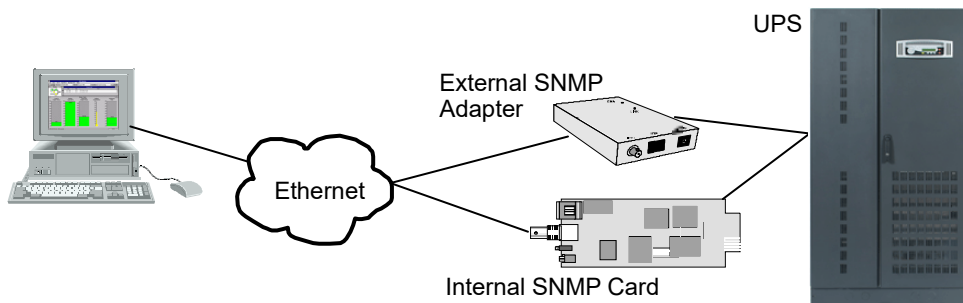

The Simple Network Management Protocol (SNMP) is a world-wide standardised communication-protocol that is used to monitor any device in a network via a simple control language. The UPS-Management Software (WAVEMON) provides data in this SNMP format with its internal software agent and can be used with any SNMP compatible operating system.

- We offer our software with SNMP functionality together with NetWare, OS/2, all Windows NT systems on INTEL and ALPHA.
- There are two types of SNMP-Adaptors available: External SNMP-Adaptor and Internal SNMP-Card (both have the same functionality). Both can manage a parallel system (N modules) and return either global values – which are consistent for the whole parallel system – or specific values from the individual modules.
- The SNMP adaptor requires a PC with terminal connections, and for normal operation at least one network connection (Ethernet) is also required.

INSTALLATION PLANNING

The following *guidelines* should be taken into account when planning a suitable UPS location and environment.

Location considerations summary

- The equipment must be installed and transported in a upright position
- The floor at the installed location and en-route from the off-loading point must be able to safely take the weight of the UPS and battery equipment
- The floor material where the UPS is to be located should be non-flammable
- Local fire protection standards must be respected
- Ensure that appropriate power supplies are available and that UPS cabling can be performed easily
- The location must be vibration free
- If the UPS is to be installed in bayed enclosures, partition walls must be installed.

Environmental considerations summary

- Avoid high ambient temperature, moisture and humidity.
Humidity (< 90% non-condensing) and temperature (+15°C / +25°C) are within prescribed limits
- A temperature of 20°C is recommended to achieve a long battery life.
- Any prescribed air cooling flow must be available. Ensure the air conditioning system can provide a sufficient amount of air cooling to keep the room at, or below, the maximum desired temperature.
- Ensure no dust or corrosive/explosive gases are present

CLEARANCES

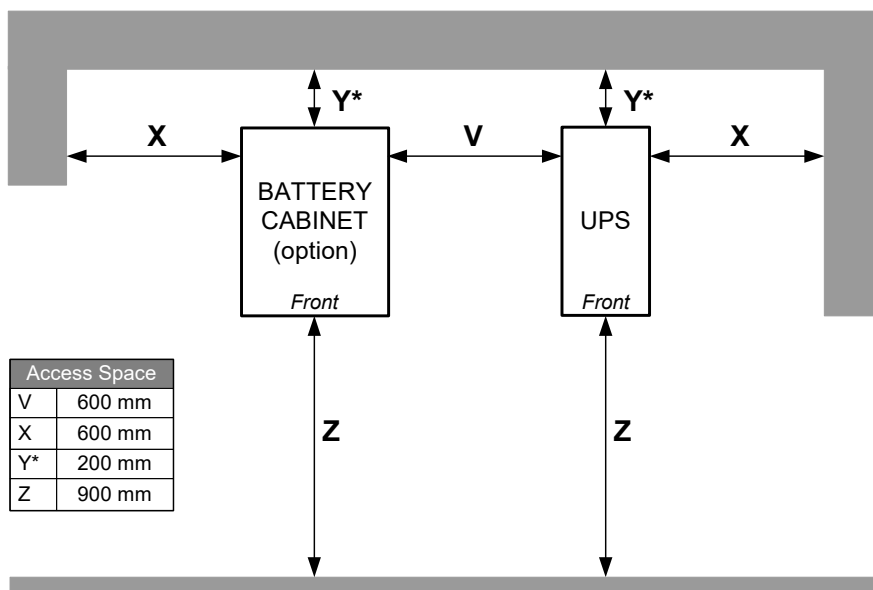

The above diagram illustrates the recommended clearances to be provided around the UPS and optional Battery Cabinet. Please read the following notes for clarification.

Notes

1. The minimum 200mm space shown at the rear of the UPS [Y] is required to allow adequate cooling air flow; however, 'A' and 'B' UPS cabinets are cabled from the rear and the UPS power switches and fuses are located on the back panel. When installing 'A' and 'B' UPS cabinets you should allow sufficient slack in the cabling to pull the UPS cabinet forward or otherwise install the UPS with sufficient rear clearance to allow cable and switch access.
2. The above diagram shows 600mm clearance [V] between the UPS and optional Battery Cabinet. This is necessary to gain side access to the UPS for service repair.
In the case of a type 'A' or 'B' UPS cabinet, if the cabling is sufficient to allow the cabinet to be pulled forward clear of the Battery Cabinet (see note 1 above) then it is not necessary to observe clearance [V], and the UPS and Battery Cabinets can be located immediately adjacent to each other.

UPS POWER CABLING

Cabinets 'A' & 'B' (10-25kVA)

All power cables are connected to terminals on the bottom of the UPS Power Board accessed through a removable panel on the lower back of the UPS.

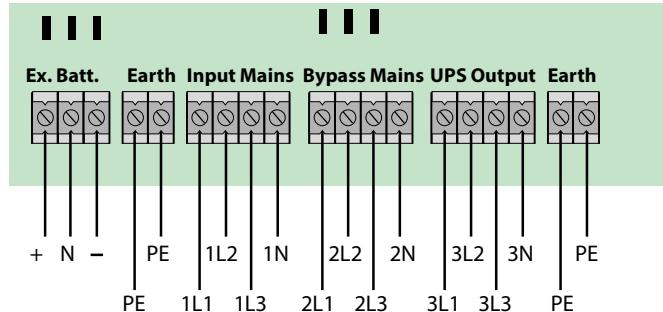

Cabinet 'C' (25-50kVA)

All power cables are connected to terminal blocks mounted on a DIN rail located in the lower front of the UPS.

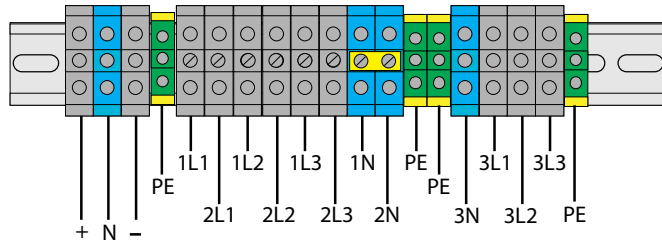

| Terminal Connections | Battery (+ / N / - / PE) | Input Bypass (3 + N) | Input Mains (3+N+PE) | Output Load (3+N+PE) | Max Cable Section | Tightening Torque |
|-------------------------------|-----------------------------|-------------------------|-------------------------|-------------------------|----------------------|----------------------|
| Cabinets 'A' & 'B' (10-25kVA) | 4 x 16mm ² | | 5 x 16mm ² | | 16mm ² | 1.5 Nm |
| Cabinet 'C' (25-50kVA) | 4 x 35mm ² | | 5 x 35mm ² | | 16mm ² | 3.5 Nm |

The UPS input/bypass terminals should be connected to the input mains/bypass supply through a LV-Distribution board and protected by a circuit breaker or fuse. This provides overload protection and also a means of isolating the UPS from the mains supply when required. Similarly, the UPS output terminals should be connected to the load equipment via a suitably fused load distribution panel.

Note: It is the customer's responsibility to provide all external fuses, isolators and cables used to connect the UPS input and output power supplies.

The UPS can be wired with a 'single feed' input (standard), whereby the UPS input supply is internally connected to the UPS bypass circuit, or it can be wired with a 'dual feed' input (shown above) – where the UPS bypass circuit is connected to a dedicated 'bypass' supply. Where a 'single feed' is used, the Input Mains and Bypass terminals are linked together on the UPS power connector blocks.

The following diagram identifies the UPS input/output cabling requirements and provides information regarding the necessary fuse and cable ratings, and cable sizing.

Fuses & Cables Quick Reference

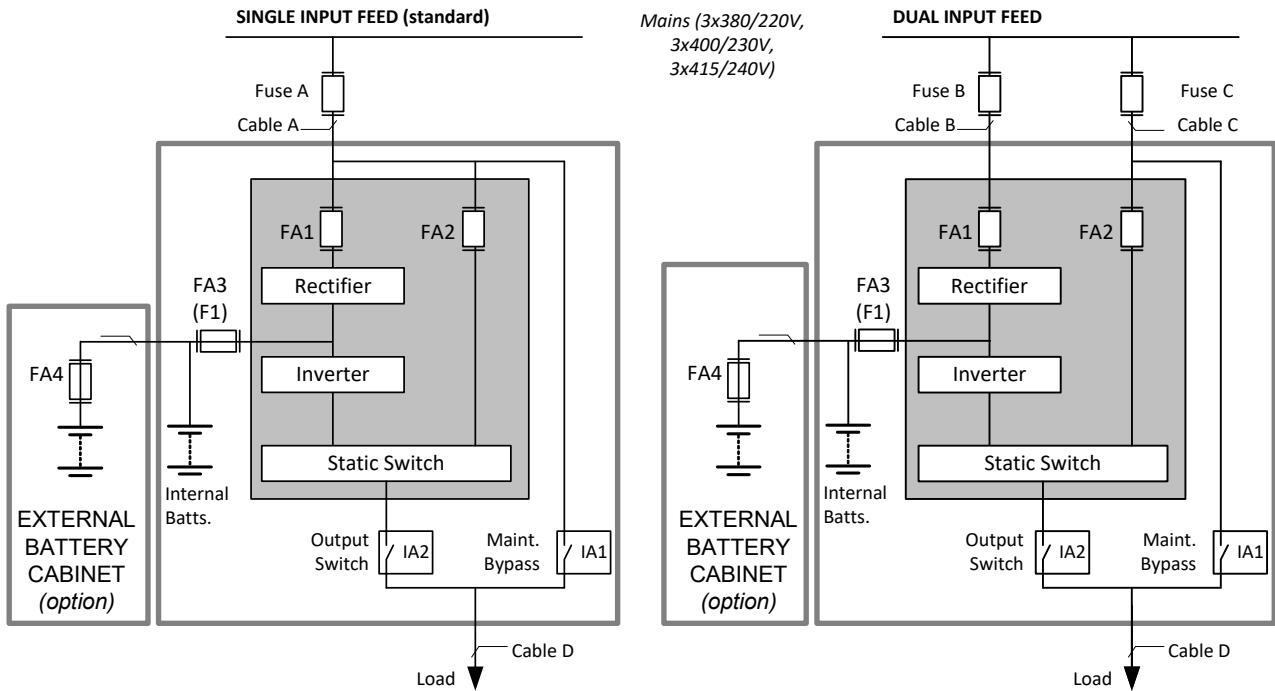

Single input feed

| Power (kVA) | Fuse A (Agl/CB) (A) | Cable A (mm ²) | Cable D (mm ²) |
|-------------|---------------------|----------------------------|----------------------------|
| 10 | 3 x 20 | 5 x 2.5 | 5 x 2.5 |
| 15 | 3 x 32 | 5 x 4.0 | 5 x 4.0 |
| 20 | 3 x 40 | 5 x 6.0 | 5 x 6.0 |
| 25 | 3 x 40 | 5 x 6.0 | 5 x 6.0 |
| 30 | 3 x 63 | 5 x 10 | 5 x 10 |
| 40 | 3 x 80 | 5 x 25 | 5 x 25 |
| 50 | 3 x 80 | 5 x 25 | 5 x 25 |

Dual input feed

| Power (kVA) | Fuse B (Agl/CB)(A) | Cable B (mm ²) | Fuse C (Agl/CB)(A) | Cable C (mm ²) | Cable D (mm ²) |
|-------------|--------------------|----------------------------|--------------------|----------------------------|----------------------------|
| 10 | 3 x 20 | 5 x 2.5 | 3 x 20 | 5 x 2.5 | 5 x 2.5 |
| 15 | 3 x 32 | 5 x 4.0 | 3 x 32 | 5 x 4.0 | 5 x 4.0 |
| 20 | 3 x 40 | 5 x 6.0 | 3 x 40 | 5 x 6.0 | 5 x 6.0 |
| 25 | 3 x 40 | 5 x 6.0 | 3 x 40 | 5 x 6.0 | 5 x 6.0 |
| 30 | 3 x 63 | 5 x 10 | 3 x 63 | 5 x 10 | 5 x 10 |
| 40 | 3 x 80 | 5 x 25 | 3 x 80 | 5 x 25 | 5 x 25 |
| 50 | 3 x 80 | 5 x 25 | 3 x 80 | 5 x 25 | 5 x 25 |

1. The fuse and cable rating details in the above tables are a recommendation only.
2. The UPS must be installed to prescribed IEC or local regulations (e.g. BS7671:2008).
3. External DC Cables and Battery fuses are bespoke to the installation.