

Technical Specification

Minipower Plus



Pioneering solutions for total power protection

MINIpowerUPS SYSTEM DESCRIPTION

Using a unique modular construction, the MINIpowerUPS model range represents a completely new generation of low power single-phase UPS systems that incorporate the latest technological developments in power engineering. High reliability, upgrade ability, low operating costs and excellent electrical performance are just some of the highlights of this innovative UPS solution. This system's advanced double conversion Voltage and Frequency Independent (VFI) topology fully satisfies the highest availability and environmentally-friendly requirements compliant with the most stringent safety, EMC and other important UPS standards. It is certified to International Standard ISO 9001/EN 29001 and ISO 14001.

The MINIpowerUPS is a truly modular system based on 1250VA power modules. Depending on the model, the MINIpowerUPS cabinet can contain up to four or eight power modules operating in parallel to provide a 5kVA or 10kVA rated UPS system.

MINIpowerUPS 5000 model range

The MINIpowerUPS 5000 is available in both Rack-mounted and Tower versions and uses up to four 1250VA power modules to offer a system output rating of 1250VA, 2500VA, 3750VA or 5000VA.

Each power module requires three batteries which are housed within the UPS cabinet to provide a completely self-contained UPS system. An optional external battery cabinet can be connected to the UPS to extend the system's autonomy time if required.

MINIpowerUPS 10000 model range

The MINIpowerUPS 10000 is available in a tower version only and uses between four and eight 1250VA power modules to offer a system output of 5000VA, 6250VA, 7500VA, 8750VA or 10000VA.

In this model range the batteries are contained in a separate battery cabinet which is similar in design and appearance to the UPS cabinet and is usually positioned adjacent to the UPS cabinet to form a matching suite.

If required, additional battery cabinets can be connected to the existing battery cabinet to extend the system's autonomy time.



System expansion

Thanks to the advanced MINIpowerUPS system design, if a cabinet is not fully populated with power modules when purchased, additional modules and batteries can be added at a later time to expand the system up to its full capacity as required. Where increased autonomy is required several battery cabinets (up to 10) can be piggy-backed onto the basic system using a simple daisy chained inter-cabinet power cables.

KEY FEATURES	
Compact size, small foot print	<i>Integral batteries, saving on expensive floor space</i>
Easy to replace UPS power modules	<i>Cost effective upgrading and reduced downtime for repair</i>
Flexible battery management	<i>Advanced management of battery charging and preventive failure diagnostics avoids premature deterioration of battery life.</i>
High efficiency	<i>Up to 92% ac-ac efficiency at 100% load</i>
Low power factor at partial and full load (p.f.>0.99 @20% load)	<i>Cost savings during installation and the entire life cycle (TCO)</i>
Blade-server-friendly power; full power from 0.9 lead to 0.8 lag	<i>No de-rating required with leading PF loads</i>
Ergonomic design	<i>Easy serviceability</i>
Technology	PWM high frequency both for input stage and output stage. Microprocessor control logic.
Synchronised Bypass	Automatic static and manual (optional). Intervenes in case of overload and operating anomaly.
Computer Interface	Standard serial RS232 for interfacing with personal computer using diagnostics software.
Remote Control	Optional scheduling of UPS switch ON/OFF and display of main UPS signals.

GENERAL SPECIFICATIONS

This Technical Specification provides detailed information concerning the mechanical, electrical and environmental performance of the MINiPowerUPS intended to support and give answers to tender and end-user requirements.

Mechanical Characteristics	MINiPowerUPS 5000				MINiPowerUPS 10000				
									
Configuration accommodates	Up to four 1250VA power modules Up to 12V, 9Ah batteries (3 per module)				Between four and eight 1250VA power modules Up to 24, 9Ah batteries (3 per module) housed in matching battery cabinet				
Cabinet type	Tower or 19 inch rack mounted				Tower cabinet only				
Size (mm) (WxDxH)	Tower: 270 x 475 x 570 19" Rack: 483.5 x 266 x 600 (6U)				270 x 475 x 570 x 2 cabinets				
	1250	2500	3750	5000	5000/2	6250/2	7500/2	8750/2	10000/2
Weight UPS Cabinet (Kg.)	23.5	34	43	53	24+50	26.5	29	31.5	34
Weight Battery Cabinet (Kg.)	-				50	57.5	65	72.5	380

Electrical Input	MINiPowerUPS 5000				MINiPowerUPS 10000				
	1250	2500	3750	5000	5000/2	6250/2	7500/2	8750/2	10000/2
Nominal Input Voltage	230V								
Input Voltage Range	184V to 264V with nominal load 100V to 264V with 50% nominal load								
Frequency	50 or 60Hz ± 2% auto-sensing and/or selected by operator								
Current (Nom.)	4.6A	8.9A	13.2A	17.7A	17.7A	22.4A	26.9A	31.25A	36.6A
Current (Max.)	5.75A	11.2A	16.6A	22.2A	22.2A	27.8A	33.25A	38.9A	44.5A
Current Distortion	<3% THD								
Power Factor	> 0.99 at 20% nominal load								
Inrush Current	100% of nominal current								
Phases	Single								
Line Fuse	25AF				32 + 32 AFF				
Battery Charger	0.8A rms (direct from mains)								

Output Waveform	MINiPowerUPS 5000				MINiPowerUPS 10000				
	1250	2500	3750	5000	5000/2	6250/2	7500/2	8750/2	10000/2
Mains Operation	Sine wave								
Battery Operation	Sine wave								
Topology	No break, on line UPS with passing neutral and double conversion								

Output Characteristics (Operating on mains)	MINIpowerUPS 5000				MINIpowerUPS 10000				
	1250	2500	3750	5000	5000/2	6250/2	7500/2	8750/2	10000/2
Nominal Output Voltage	230 V ± 1%								
Nominal Output frequency	50 Hz / 60Hz synchronised (auto-sensing and/or as selected by operator)								
Output Current with linear load and 0.7 pf (A rms)	5.37	10.75	16.25	21.6	21.6	27.2	32.6	38	43.5
Crest Factor	3.5								
Output VA	1250	2500	3750	5000	5000	6250	7500	8750	10000
Output W with 0.7 pf linear/non-linear load	875	1750	2625	3500	3500	4375	5250	6125	7000
THD	< 0.5% with nominal load and < 1% with 0.7 pf nominal non-linear load								
Overload Capacity	300% for 1s, 200% for 5s and 150% for 30s without By-pass intervention								
Phases	Single								
AC-AC conversion efficiency with linear load pf=1 and charged batteries	80% with 50% load 85% with 75% load 92% with 100% load								

Output Characteristics (Operating on battery)	MINIpowerUPS 5000				MINIpowerUPS 10000				
	1250	2500	3750	5000	5000/2	6250/2	7500/2	8750/2	10000/2
Nominal Output Voltage	230 V ± 1%								
Nominal Output frequency	50 Hz / 60Hz synchronised (auto-sensing and/or as selected by operator)								
Output VA	1250	2500	3750	5000	5000	6250	7500	8750	10000
Output W with 0.7 pf linear/non-linear load	875	1750	2625	3500	3500	4375	5250	6125	7000
THD	< 1%								
Overload Capacity	160% for 15s								
Allowable load pf	0.7-1.0								
DC-AC conversion efficiency	80% efficient with loads from 50% to 100% (with linear load pf=1 and charged batteries)								



WARNING: There is a danger of explosion should the batteries be replaced with the wrong type. Dispose of used batteries as per the instructions and precautions detailed on the battery label.

Battery Operation	MINIpowerUPS 5000											
	1250			2500			3750			5000		
Percentage load	50	80	100	50	80	100	50	80	100	50	80	100
*Standard autonomy (min)	20	11	8	20	11	8	20	11	8	20	11	8
Recharge time to 90% charge	5 - 6 hours according to level of discharge											
Battery specifications	3 x 12V 9Ah, sealed, lead-acid, maintenance free batteries connected in series for each power module											
Reserve signals	32.2 V to 36V, programmable											
Minimum voltage for battery operation during discharge	27V to 31.5V with automatic selection depending on applied load, or as programmed by operator.											
Average battery life	3-6 years according to use and working temperature. The UPS batteries are subject to a reduction in capacity depending on their age. For example, the reduction of capacity of a 4-year-old battery can be as much as 40%, resulting in a proportional reduction of UPS autonomy time when running on battery power.											
<i>*Approximate autonomy in minutes with fully charged batteries</i>												

Battery Operation	MINIpowerUPS 10000														
	5000/2			6250/2			7500/2			8750/2			10000/2		
Percentage load	50	80	100	50	80	100	50	80	100	50	80	100	50	80	100
*Standard Autonomy	20	11	8	20	11	8	20	11	8	20	11	8	20	11	8
Recharge time to 90% charge	5 - 6 hours according to level of discharge														
Battery specifications	3 x 12V 9Ah, sealed, lead-acid, maintenance free batteries connected in series for each power module														
Reserve signals	32.2 V to 36V, programmable														
Minimum voltage for battery operation during discharge	27V to 31.5V with automatic selection depending on applied load, or as programmed by operator.														
Average battery life	3-6 years according to use and working temperature The UPS batteries are subject to a reduction in capacity depending on their age. For example, the reduction of capacity of a 4-year-old battery can be as much as 40%, resulting in a proportional reduction of UPS autonomy time when running on battery power.														
<i>*Approximate autonomy in minutes with fully charged batteries</i>															

Bypass Operation	MINIpowerUPS 5000				MINIpowerUPS 10000				
	1250	2500	3750	5000	5000/2	6250/2	7500/2	8750/2	10000/2
Type	Static and electromechanical								
Switchover time	Zero								

Reference Standards	MINIpowerUPS 5000				MINIpowerUPS 10000				
	1250	2500	3750	5000	5000/2	6250/2	7500/2	8750/2	10000/2
Safety	Conforms to standard EN 62040-1-1								
Electromagnetic compatibility	Immunity: Conforms to standard EN 50091-2 (class A) Emissions: Conforms to standard EN 50091-2 (class B)								
Typical Performance	Conforms to standard EN 62040-3								

Communication Options	
Power Management Display (PMD)	LCD display showing operating and alarm status (with event history)
RS232 Comms Port on 9-pin D-type connector	For monitoring integration in network management and service
Customer Interface (Logic level output) on 9-pin and 15-pin D-type connectors	

Environmental	MINIpowerUPS 5000				MINIpowerUPS 10000				
	1250	2500	3750	5000	5000/2	6250/2	7500/2	8750/2	10000/2
Storage Altitude	10.000 metres								
Storage Temperature	-20°C to +50°C								
Operating Temperature	0°C to +40°C								
Relative Humidity	20-80% non-condensing								
Protection	IP 21 (IEC529)								
Audible Noise	< 40dBA at 1 metre								

POWER MANAGEMENT DISPLAY (PMD)

The user-friendly control panel comprises three areas:

Alpha-numeric LCD Display

Normally provides indication of the UPS operating mode together with the input/output supply parameters and the battery 'state of charge' (SOC). It can also display error messages and UPS set-up data via the control menuing system

Operator Keypad

Provides keys to navigate through the UPS control menu system together with an ON/OFF button.

Operating status indicator

The area behind the mimic diagram is illuminated by a multi-coloured led to indicate the UPS operating status.

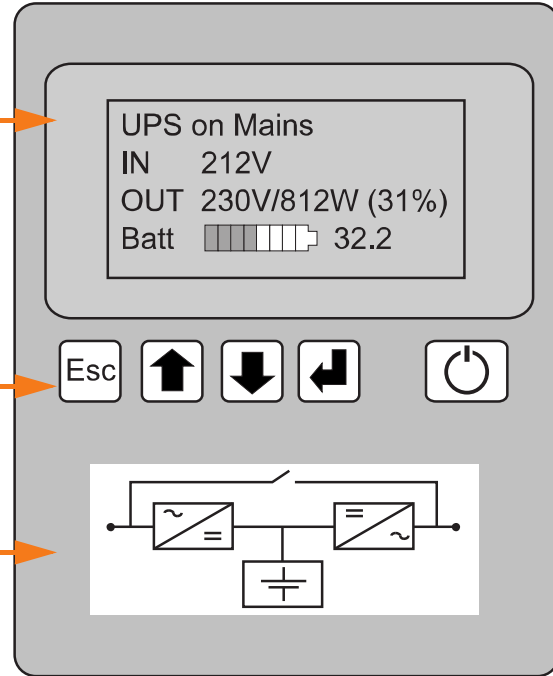

Alpha-numeric LCD Display Panel

A multi-function LCD Display provides a simple communications interface that enables the operator to monitor important UPS operating parameters and alarm warnings. It also allows the operator to undertake various control operations such as transferring the load between the inverter and bypass. The display is menu-driven using the UP/DOWN and ENTER buttons.

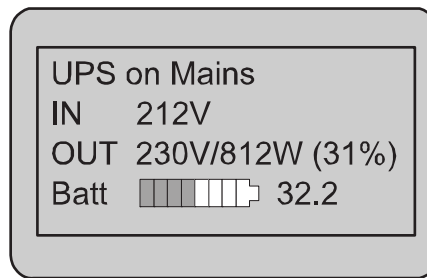





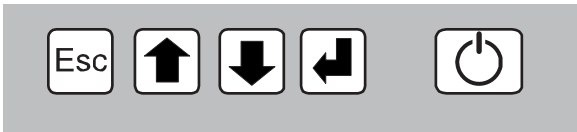

UPS	On Mains	Normal operating status when the input mains voltage is present.
	On Battery	There is no mains power and the UPS is running on its batteries.
	On By-pass	The UPS internal bypass circuit has been turned on and the UPS output is connected directly to the UPS input mains supply.
IN	xxxV	Indicates the UPS input voltage and the RMS power (W) taken from the mains. This indication is not displayed during battery operation.
OUT	xxxV/x,xKW (xx%)	Indicates the output voltage and power. The power is shown in kW and also as the percentage of the total power that the UPS is able to supply.
Batt.	xx,x	Indicates the battery state of charge in a bar graph format together with a numerical indication of the available autonomy time (in minutes).

LCD Display Panel summary:

- Displays the input and output voltage, current, frequency and power
- Displays an 'Event register' which stores a date/time stamped history of the 99 most recent alarms and events
- Enables battery run time monitoring
- Enables selection of commands such as UPS Start-up and Shut-down, Load transfer from inverter to bypass and vice-versa
- Provides diagnostic facilities (service mode only)
- In conjunction with the operator keys, provides UPS adjustments and functional testing facilities (service mode only)

Operator Keypad

	
	<p>ESCape Key</p> <ul style="list-style-type: none"> • Exit a function without modifying it • Go up one menu level • Exit the main menu and return to the status display • Silence the buzzer
	<p>SCROLL UP Key</p> <ul style="list-style-type: none"> • Select previous function • Increase a value • Select a new item within the function (e.g. go from DISABLED to ENABLED)
	<p>SCROLL DOWN Key</p> <ul style="list-style-type: none"> • Select next function • Reduce a value • Select a new item within the function (e.g. go from ENABLED to DISABLED)
	<p>ENTER (SELECT) Key</p> <ul style="list-style-type: none"> • Confirm a value • Access an item in the menu • Go down a menu level
	<p>ON/OFF</p> <ul style="list-style-type: none"> • UPS ON/OFF pushbutton

COMMUNICATIONS OPTIONS

Three D-type connectors are fitted on the UPS back panel to facilitate connection to a range of external communication options.

The RS232 Interface can be connected to various shutdown and monitoring software applications whereas the Logic Level interfaces are generally used to drive a more simplified remote alarms monitor panel.

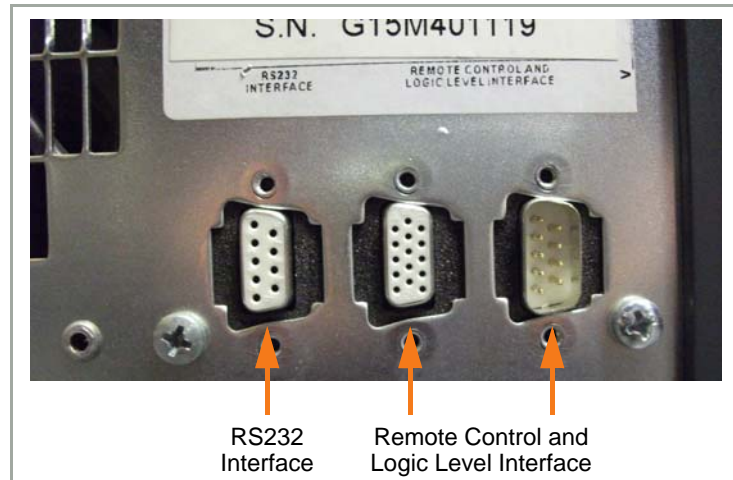

Shutdown and monitoring Software

Four monitoring systems are available for use with the MINIpowerUPS UPS system:

- WAVEMON – can be used for monitoring and automatic shutdown
- SNMP – can be used for monitoring only
- PowerREPORTER – can be used to automatically email UPS monitored parameters and alarm events to Uninterruptible Power Supplies Ltd. for appropriate response
- RELAY INTERFACE BOARD – provides volt free contacts for connecting to a remote alarm monitor

WAVEMON UPS monitoring software

WAVEMON is designed to operate with many of the Uninterruptible Power Supplies Ltd. UPS systems and features both monitoring and automatic server/UPS shutdown facilities. The system comprises a bespoke software package which is installed on a local PC and communicates with the UPS over a standard RS232 cable connected to the RS232 port on the UPS back panel. The interconnecting RS232 cable can be up to 15m in length and may be connected/disconnected whilst the UPS is running.

The main characteristics of WAVEMON are:

- On-screen autonomy time/battery time countdown
- On-screen server log off and shutdown procedure
- Time and date stamp event log
- Extensive logging of all UPS activity and power quality data
- Allow alarm warnings to be monitored remotely via email
- Scheduled UPS service mode and other systems status
- Graphical user interface for Windows-compatible platforms
- Automatic unattended local shutdown
- Special modules for MS-Office software to close and save open documents
- Compatible with all optional modules like UPSDIALER, SNMP adaptors, temperature sensors, etc.

SNMP ADAPTER for network management/remote monitoring

Simple Network Management Protocol (SNMP) is a world-wide standardised communication protocol that can be used to monitor any network-connected device via a simple control language. The monitored results are displayed in a web browser.

When this facility is used in conjunction with the MINIpowerUPS, an external SNMP adapter is used which is connected to the RS232 connector on the UPS back panel. The SNMP adapter is then connected to the network by means of a standard RJ-45 terminated Ethernet connector, and the UPS-Management software agent installed in the SNMP adapter monitors the UPS operating parameters and outputs its data in SNMP format to the connected network.

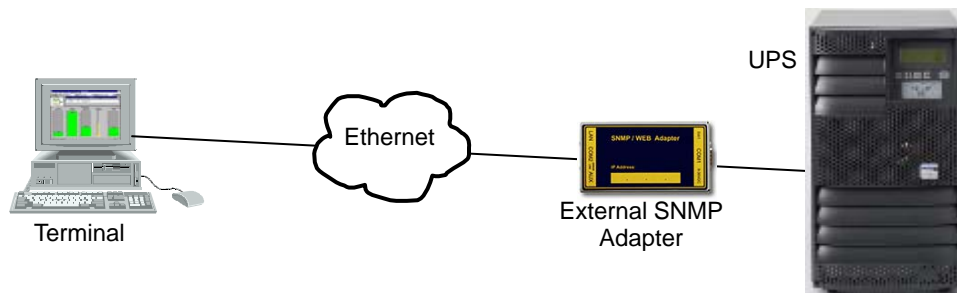

The external SNMP adapter is enclosed in a small box which must be powered from a backed-up supply supported by the UPS output so that its power is maintained in the event of a mains failure. A suitable plug-top power supply is included with the option kit.

Note: It is the customer's responsibility to provide a suitable, backed-up mains supply for the adapter.

In order to use this adapter the operating system you are using must be SNMP-compatible. We offer our software with SNMP functionality together with NetWare, OS/2, all Windows NT systems on INTEL and ALPHA. The SNMP adapter requires a PC with terminal connections and, for normal operation, at least one Ethernet network connection.

PowerREPORTER™ management software

PowerREPORTER™ is a remote monitoring and management service which is a part of the premium power protection concept.

ThePowerREPORTER™ application:

- Provides affordable, continuous monitoring over mission-critical facilities and offers peace-of-mind by detecting and warning of any potential system problems before they become a crisis. I
- Acquires key performance parameters and productivity information in real-time to enable you to better understand machine performance and faster troubleshoot downtime events
- Gives total transparent information concerning all actions performed on the system, such as all critical status changes, coordination of equipment service, reporting of all alarms with priorities

Key features

- Redundant and secure communication
- Alarm acknowledgment
- Priority driven Management (with escalation)

Comprehensive management system

- Reception and management of alarm calls from UPS
- Storage of UPS Data in a database exportable in a CSV-format for easy handling in Excel
- Unlimited number of UPS that can be managed
- User administration with passwords and permission-level
- Administration of Log file
- Data logging with statistical analysis and diagnostics, report
- Visualization of the UPS data
 - Current status
 - Measured values for single or three phase
 - Recording function including graphs with zooming capabilities for selected measured values
 - Display of event log file
 - Display of UPS Parameters
 - Web Server functionality, for data access from any Web Browser

Logic Level Interface

The outputs from the Logic Level Interface (9-pin and 15-pin) connectors are normally used to drive a basic remote alarms panel. The available output signals are shown below:

9-pin	15-pin	
1	5	Input ON/OFF (Max. voltage +15V, equivalent to the ON/OFF button on the front control panel)
2	4	+15V (max 30mA)
3	3	AUTONOMY RESERVE (active high 15V, max 5mA)
4	2	UPS RUN ON BATTERY (active high 15V, max 5mA)
5	1	GND (common)
6	15	GENERAL ALARM (Open collector active low, max 50mA)
7	14	AUTONOMY RESERVE (Open collector active-low, max 50mA)
8		GND (common)
9	12	UPS RUN ON BATTERY (Open collector active-low, max 50mA)
	7	OVERLOAD (Open collector active-low, max 50mA)

Relay Interface Board

An optional Relay Interface Board is available to act as an interface between the UPS and a remote alarms panel. This option contains three changeover relays that are controlled by the UPS Logic Level outputs to provide volt free signalling to the remote panel.

The board is contained in an ABS box which is fitted to the UPS back panel and connected to the 9-pin D-type connector on the back of the UPS by means of the supplied 0.6m ribbon cable.

The board's outputs can be wired to provide indication of:

- UPS on Mains
- UPS on Battery
- General UPS fault detected
- Low battery – (UPS has been operating on battery power and the remaining autonomy time is low.)

Note: All relay contacts are rated at 150Vdc / 125Vac and 1A.

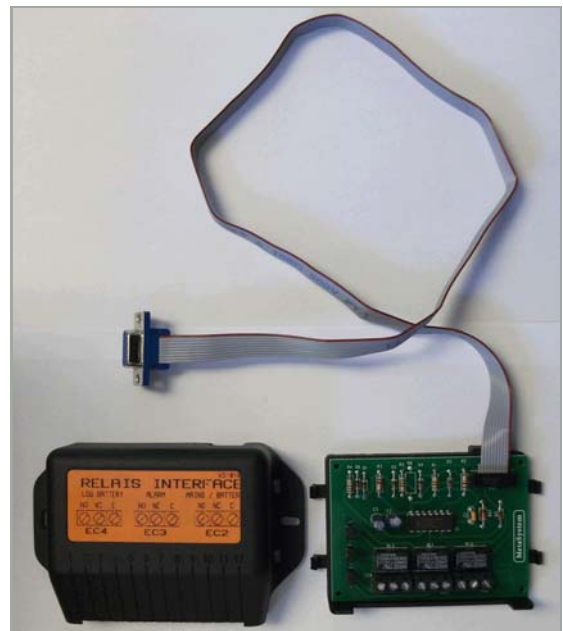

INSTALLATION PLANNING

The following *guidelines* should be taken into account when planning a suitable UPS location and environment.

Location considerations summary

- The UPS equipment must be installed and transported in a upright position.
- The floor at the installed location and en-route from the off-loading point must be able to safely take the weight of the UPS and battery equipment.
- The floor material where the UPS is to be located should be non-flammable.
- Local fire protection standards must be respected.
- The location must be vibration free.

Environmental considerations summary

- Ensure the humidity (< 90% non-condensing) and temperature (+15°C to +25°C) are within prescribed limits.
- An ambient temperature of 20°C is recommended to achieve a long battery life.
- Any prescribed air cooling flow must be available. Ensure the air conditioning system can provide a sufficient amount of air cooling to keep the room at, or below, the maximum desired temperature.
- Ensure no dust or corrosive/explosive gases are present.

CLEARANCES

Tower cabinets

The MINIpowerUPS 5000/10000 UPS Tower cabinet is compact and mounted on wheeled castors so that it can be easily moved to its intended operating location.

As shown in the illustration alongside, the UPS and battery cabinets require a minimum of 200 mm clearance at the rear and either side to permit adequate cooling airflow. However, in each case full rear access is required for cabling, and side access is necessary for maintenance and repair. For this reason it is recommended that the cabinets are located so that they can be wheeled forward to provide the necessary side and rear access when required.

This recommendation must be taken into consideration when cabling the equipment so that a sufficient cable length is provided to allow for the prescribed cabinet movement.

A space of 900 mm is shown at the front of the cabinets. This allows adequate room for the safe passage of personnel during normal operation and also sufficient space for the cabinets to be pulled forward for access, as described above.

Ensure that the cabinet is located in an area where the ventilation grills are unlikely to be accidentally covered.

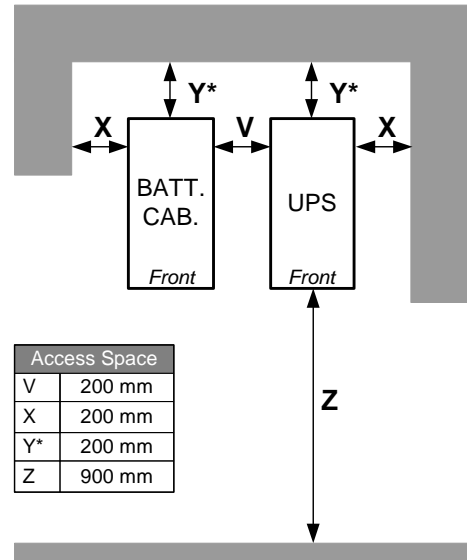

Rack-mounted cabinets

The MINIpowerUPS Rack-mounted cabinet is designed to fit into a standard 19 inch rack and is 6U high. The cabinet is fitted through the front of the rack, supported on suitable rails and secured in position by means of two screws on each side of the front of the assembly.

All MINIpowerUPS 5000 Rack-mounted UPS cabinets contain the UPS batteries; however a matching rack-mounted battery cabinet is available if an extended battery facility is required.

Where used, the separate battery cabinet (also 6U) and UPS cabinet should preferably be fitted in the same rack and positioned immediately adjacent to each other.

Due to the weight of the assembly it is usual to mount the UPS cabinet in the bottom of the rack and the optional battery cabinet (where used) mounted immediately above it.

There is no minimum space requirement above or below the UPS cabinet when it is in-situ, but a minimum of 200mm must be provided at the rear of the unit to allow for adequate cooling air flow and facilitate cabling. As the UPS cabinet is 600mm deep this implies a minimum rack depth of 800mm.

As rear access is required for cabling, sufficient space should be provided behind the rack to permit easy passage – recommended 900mm. A similar space is required at the front of the rack to enable the UPS cabinet to be handled while it is being installed.

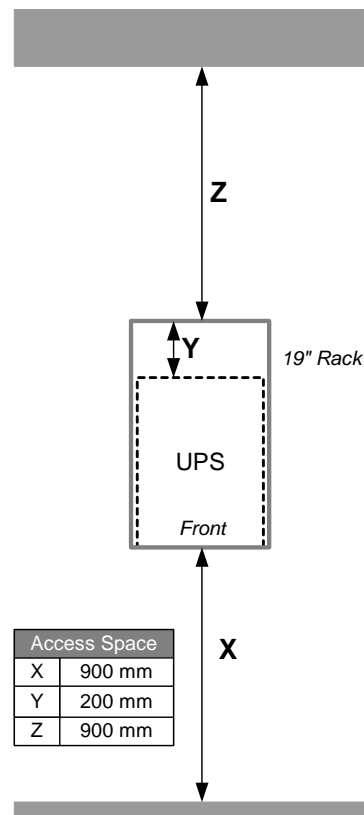

UPS POWER CABLING

The UPS input and output cables are fitted to a single power connector that plugs into a receptacle located on the rear of the UPS cabinet. A ready-cabled connector of approximately 600mm in length, and terminated with an input plug and outlet socket suitable for the UPS capacity rating, is provided with the equipment. Where a separate battery cabinet is employed a purpose-made cable is also supplied suitable for connecting the battery cabinet to the UPS.

Note: The UPS must be installed to prescribed IEC or local regulations (e.g. BS7671:2008).

Extended battery cabinet connections

Additional battery cabinets can be connected to the UPS system to further extend the available autonomy time.

Where an extended battery cabinet is used, the standard cabinet inter-connect cables are replaced by 'splitter' cables that can be effectively daisy chained to connect any number of cabinets together.

When several cabinets are connected as shown, the battery charger within the UPS cabinet may be inadequate to fully charge all the additional batteries. In this case an independent battery charger is fitted to each extended battery cabinet which must be connected to a mains supply using a standard IEC power cord.

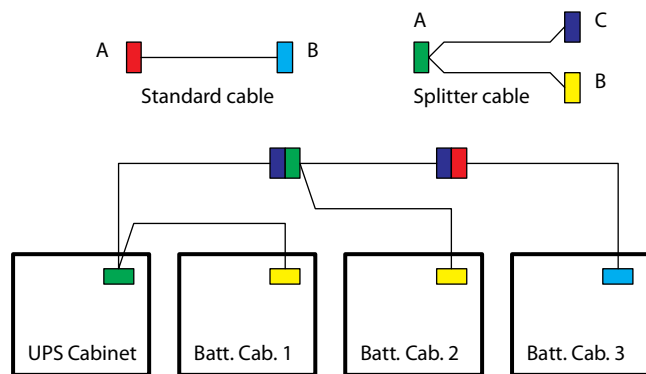

Maintenance bypass option

A Maintenance Bypass option is available which allows the load equipment to be powered from the raw mains supply when the UPS is totally powered down. Where the option is used, the Maintenance Bypass switch is built into the UPS power connector and requires no modification to the UPS.

When the Maintenance Bypass switch is closed, the UPS power connector can be disconnected from the UPS whilst maintaining the (raw) load supply. This allows the completed UPS cabinet to be swapped out for repair if required without disturbing the load supply.

